

soundcore

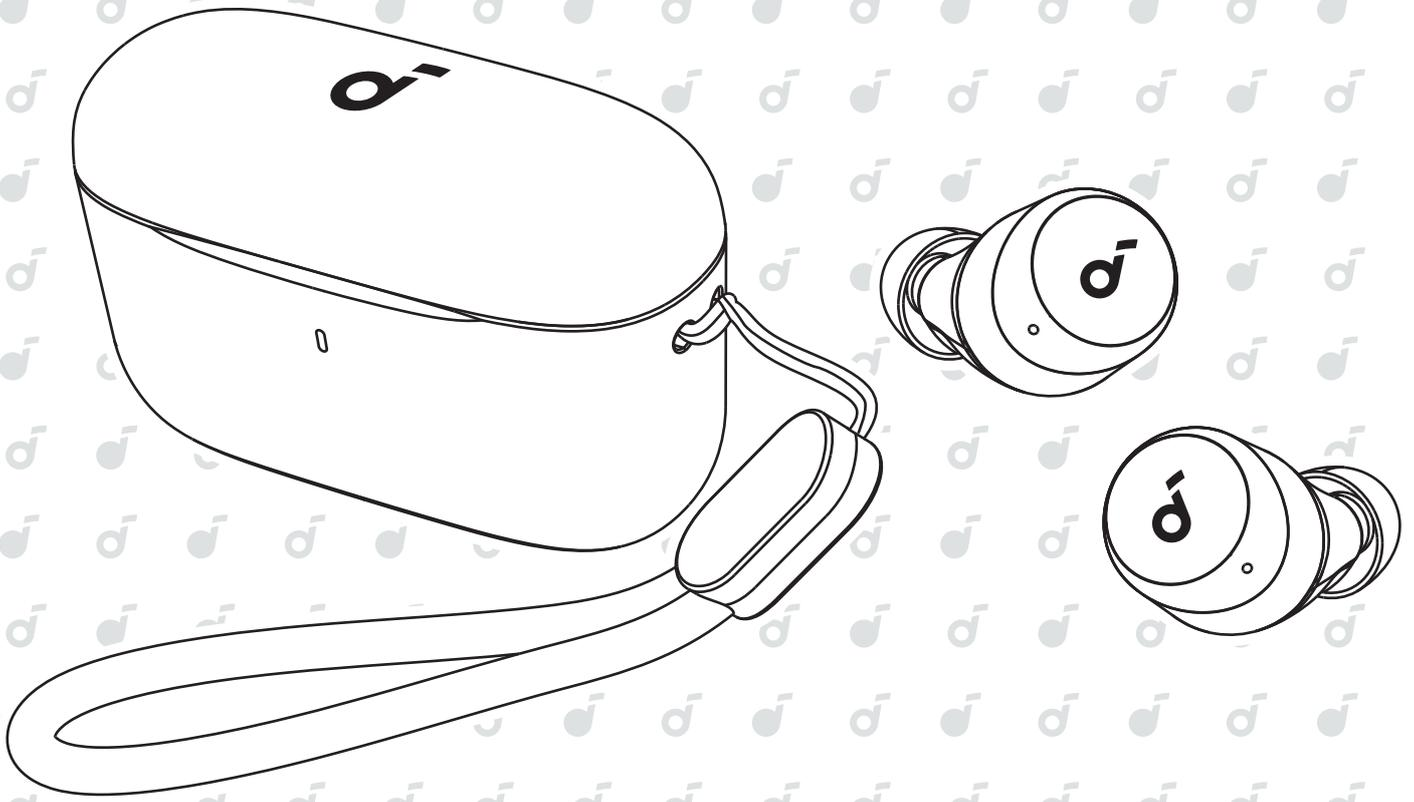

soundcore A20i/A25i

**USER MANUAL**

English	01	Português	40
Čeština	04	Portugues do Brasil	43
Dansk	07	Русский	46
Deutsch	10	Slovenský Jazyk	49
ελληνικά	13	Slovenski Jezik	52
Español	16	Svenska	55
Suomi	19	Türkçe	58
Français	22	日本語	61
Magyar	25	한국어	64
Italiano	28	简体中文	67
Nederlands	31	繁體中文	70
Norsk	34	لَعَرَبِيَّة	73
Język polski	37	עברית	76



## APP



Google Play and the Google Play logo are trademarks of Google Inc.



Apple and the Apple logo are trademarks of Apple Inc.



Download the soundcore app to enhance your experience (Gaming mode, Find device, EQ tuning, Firmware update, and more). If your earbuds don't connect with the soundcore app, update it to the latest version in your mobile app store.



## WEARING

1



2

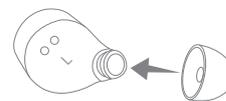

Choose the ear tips that fit your ears best.



## CHARGING

1

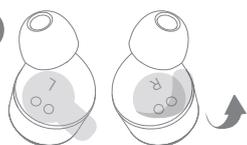

2

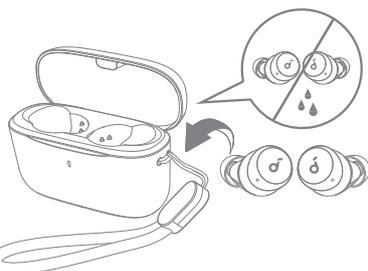

3

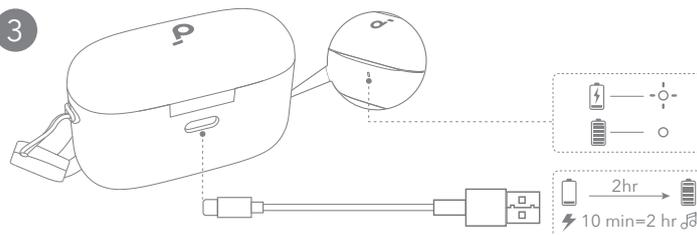

1. Tear off the insulation sticker on the earbuds before first use.
  2. Place the earbuds in the charging case and close it.
- Fully dry off the earbuds and the USB-C charging port before charging.

3. Connect the charging case to a power supply by using a certified USB-C charging cable.
- Fully charge both the earbuds and the charging case before first use.



## POWERING ON & PAIRING

1

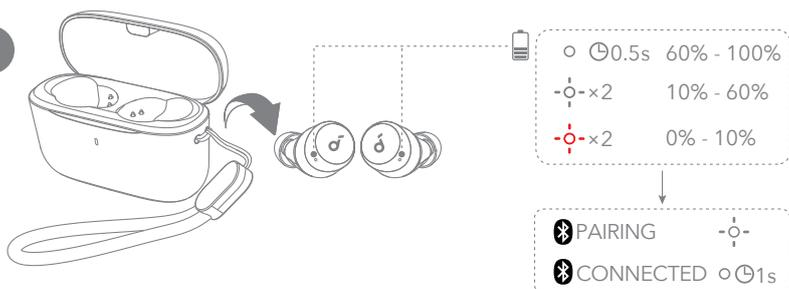

2

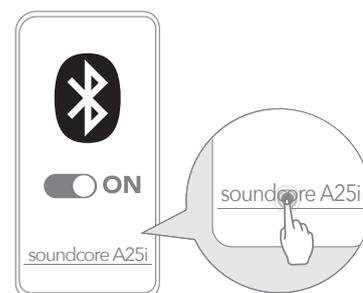

Open the charging case and take the earbuds out. They will automatically power on and enter Bluetooth pairing mode.

Select **"soundcore A20i / A25i"** \* on your device's Bluetooth list when connecting for the first time.

\*The device name may vary depending on the region.

# MANUAL PAIRING

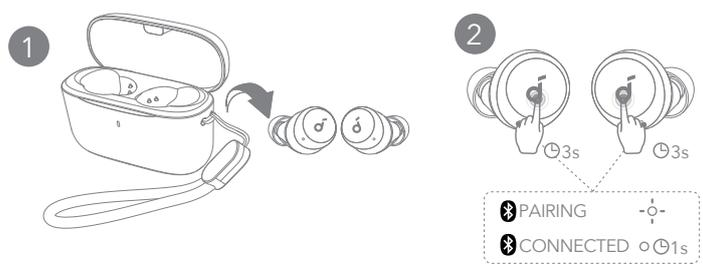

To manually enter Bluetooth pairing mode, take the earbuds out of the case, then tap and hold the touchpads on both earbuds for 3 seconds until the earbuds' LED indicators flash white rapidly.

# CONTROLS

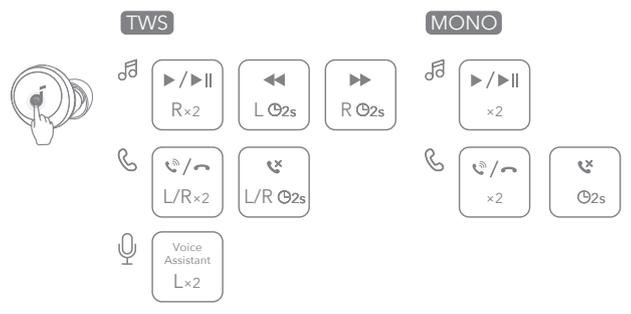

You can also customize controls in the soundcore app.

# CONTROLS

	TWS mode	Mono mode
Play / Pause	Tap twice (R)	Tap twice
Previous track	Tap and hold for 2 seconds (L)	/
Next track	Tap and hold for 2 seconds (R)	/
Answer / End a call	Tap twice (L/R)	Tap twice
Reject a call	Tap and hold for 2 seconds (L/R)	Tap and hold for 2 seconds
Activate voice assistant software	Tap twice (L)	/

# POWERING OFF

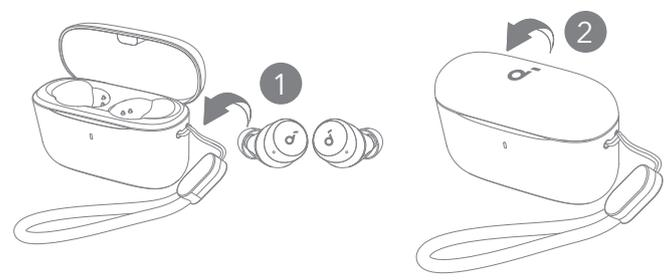

To power off, return the earbuds to the charging case and close it. The earbuds will automatically power off after 30 minutes if they are not connected.

# RESET

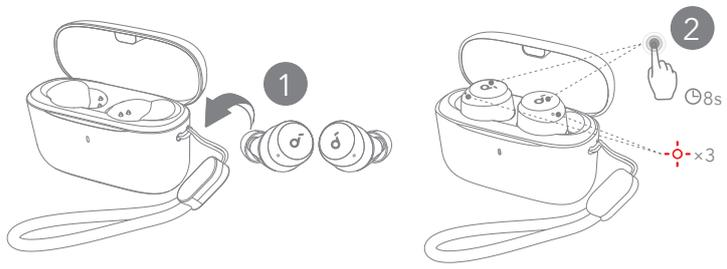

Reset if the earbuds have issues pairing with each other or with other devices. Place the earbuds in the charging case and leave the case open, then tap and hold the touchpads on both earbuds for 8 seconds until the earbuds' LED indicators flash red rapidly three times.

# LED LIGHT GUIDE

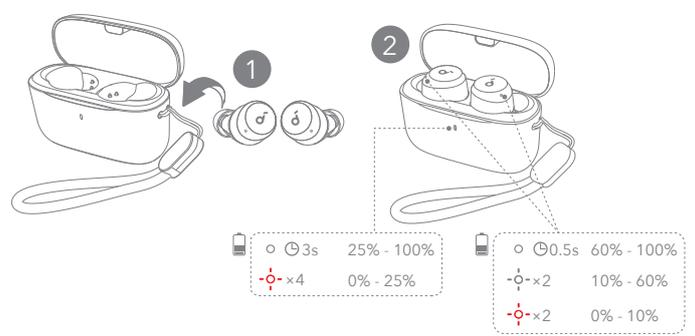

- Steady white
- Flashing white
- Flashing red



## FIRMWARE UPDATE

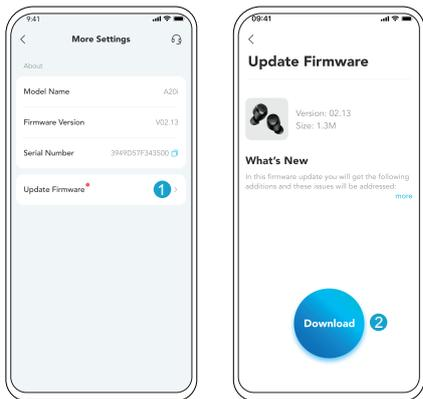

You will be notified once a new firmware version is detected when you connect the earbuds to the app. Ensure the earbuds are placed in the charging case and the case remains open until the firmware update is complete. During the update, make sure the earbuds are being charged and avoid any usage.



## SPECS

Specifications are subject to change without notice.

Input	5V $\overline{\text{---}}$ 0.5A
Rated output power	5mW
Battery capacity	60mAh $\times$ 2 (earbuds); 350Ah (charging case)
Charging time	Up to 2 hours
Playtime (varies by volume level and content)	Up to 9 hours (up to 28 hours with the charging case)
Driver unit	6mm dynamic driver
Frequency response	20Hz - 20kHz
Impedance	16 $\Omega$
Waterproof level (earbuds)	IPX5
Bluetooth version	5.3
Bluetooth range	10m / 33ft



## APLIKACE



Google Play and the Google Play logo are trademarks of Google Inc.



Apple and the Apple logo are trademarks of Apple Inc.



## NOŠENÍ

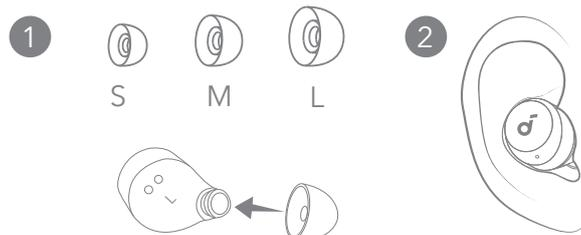

Stáhněte si aplikaci Soundcore pro zlepšení svého zážitku (režim hraní, hledání zařízení, ladění EQ, aktualizace firmwaru a další). Pokud sluchátka nelze připojit k aplikaci soundcore, aktualizujte ji na nejnovější verzi prostřednictvím obchodu s mobilními aplikacemi.

Zvolte si nástavce, které vám nejlépe sedí v uších.



## NABÍJENÍ

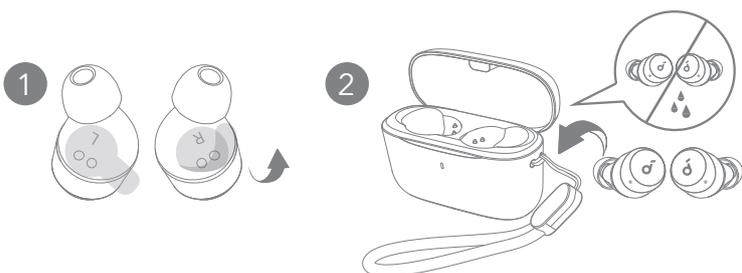

1. Před prvním použitím ze sluchátek odtrhněte izolační nálepku.
2. Sluchátka vložte do nabíjecího pouzdra a zavřete ho.

• Sluchátka a nabíjecí port USB-C před nabíjením úplně vysušte.

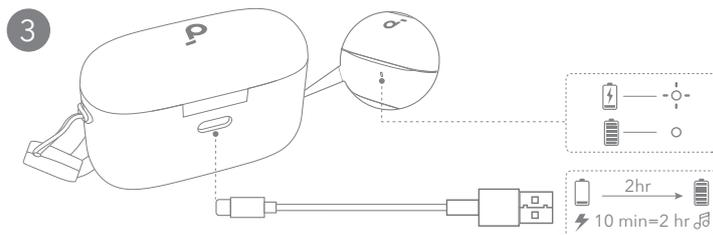

3. Připojte nabíjecí pouzdro k napájení pomocí certifikovaného nabíjecího kabelu USB-C.
- Před prvním použitím plně nabijte obě sluchátka i nabíjecí pouzdro.



## ZAPNUTÍ A PÁROVÁNÍ

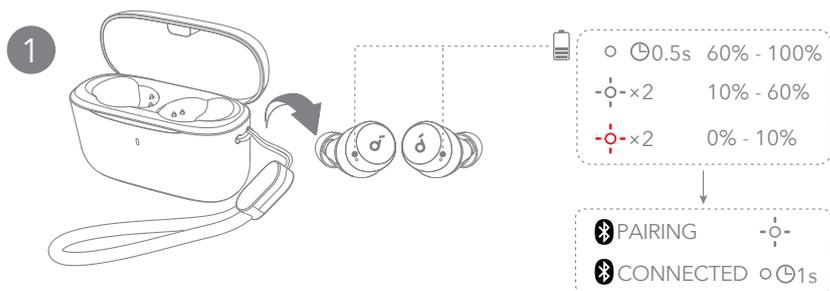

Otevřete nabíjecí pouzdro a vyberte sluchátka. Automaticky se zapnou a přejdou do režimu párování Bluetooth.

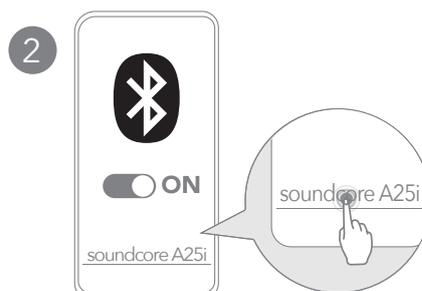

Při prvním připojení vyberte ze seznamu Bluetooth zařízení „**soundcore A20i / A25i**“\*.

\*Název zařízení se v závislosti na regionu může lišit.



## RUČNÍ PÁROVÁNÍ

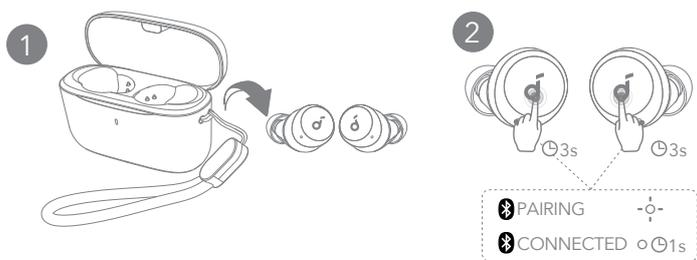

Pro manuální párování Bluetooth připojení vyjměte sluchátka z pouzdra, poté klepněte a podržte dotykové plochy na obou sluchátkách po dobu 3 sekund, dokud LED kontrolky sluchátek rychle nezačnou blikat bíle.



## OVLÁDÁNÍ

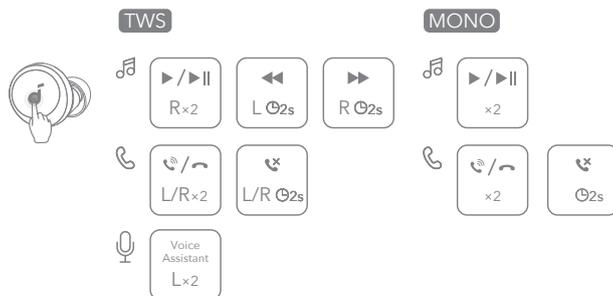

V aplikaci Soundcore si můžete také přizpůsobit ovládací prvky.



## OVLÁDÁNÍ

	Režim TWS	Mono režim
Přehrát / pozastavit	Klepněte dvakrát (P)	Klepněte dvakrát
Předchozí skladba	Podržte po dobu 2 sekund (L)	/
Následující skladba	Podržte po dobu 2 sekund (P)	/
Přijmout/ukončit hovor	Klepněte dvakrát (L/P)	Klepněte dvakrát
Zamítnout hovor	Klepněte a podržte po dobu 2 sekund (L/P)	Stiskněte a podržte 2 sekundy
Aktivace softwaru hlasového asistenta	Klepněte dvakrát (L)	/



## VYPNUTÍ

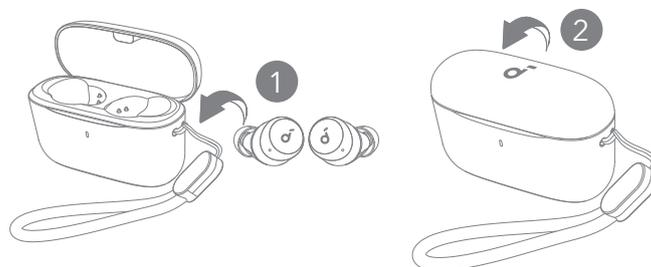

Sluchátka vypnete jejich vrácením do nabíjecího pouzdra a zavřením pouzdra. Sluchátka se automaticky vypnou po 30 minutách, pokud nejsou připojena.



## RESETOVÁNÍ

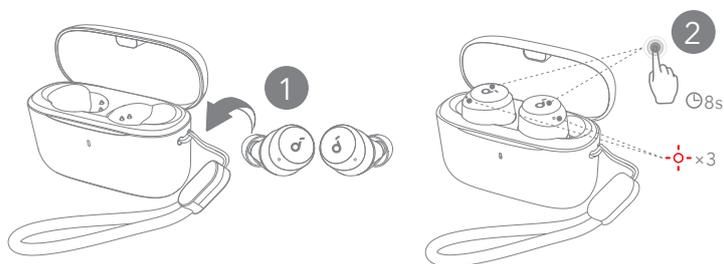

Resetování provedte, pokud se nedaří spárování sluchátek nebo spárování s jinými zařízeními. Umístěte sluchátka do nabíjecího pouzdra a nechte pouzdro otevřené, poté klepněte a podržte dotykové plochy na obou sluchátkách po dobu 8 sekund, dokud LED kontrolky sluchátek nezačnou rychle třikrát blikat červeně.



## POPIS FUNKCÍ LED KONTROLEK

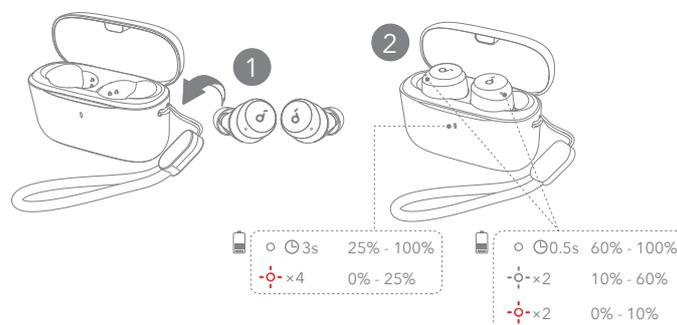

- Svítí bíle nepřerušovaně
- Bliká bíle
- Bliká červeně

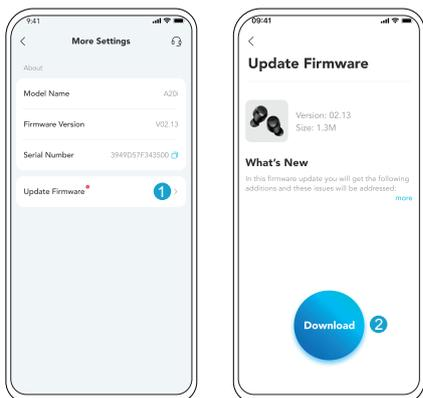

Po připojení sluchátek k aplikaci budete informováni, jakmile bude detekována nová verze firmware. Ujistěte se, že sluchátka jsou umístěna v nabíjecím pouzdře a pouzdro zůstává otevřené, dokud není dokončena aktualizace firmware. Během aktualizace se ujistěte, že se sluchátka nabíjí a vyhněte se jakémukoli používání.

Specifikace se mohou bez předchozího upozornění změnit.

Vstup	5 V $\overline{\text{---}}$ 0,5 A
Jmenovitý výstupní výkon	5 mW
Kapacita baterie	60 mAh $\times$ 2 (sluchátka); 350 Ah (nabíjecí pouzdro)
Doba nabíjení	Až 2 hodiny
Doba přehrávání (liší se podle hlasitosti a obsahu)	Až 9 hodin (až 28 hodin s nabíjecím pouzdrem)
Řídící jednotka	6mm dynamický reproduktor
Frekvenční rozsah	20 Hz - 20 kHz
Impedance	16 $\Omega$
Stupeň vodotěsnosti (sluchátka)	IPX5
Verze Bluetooth	5.3
Dosah připojení Bluetooth	10 m



## APP



Google Play and the Google Play logo are trademarks of Google Inc.



Apple and the Apple logo are trademarks of Apple Inc.



Download soundcore-appen for at forbedre din oplevelse (Gaming-tilstand, Find enhed, EQ-justering, Firmware-opdatering og mere). Hvis dine øretelefoner ikke kan oprette forbindelse til soundcore-appen, skal du opdatere den til den nyeste version i din mobilappbutik.



## PLACERING I ØRET

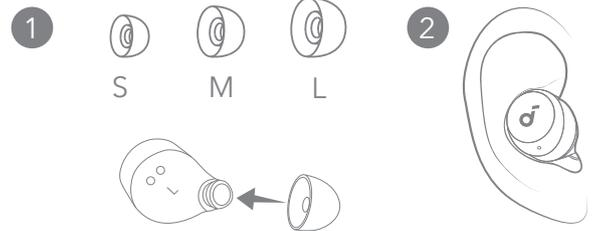

Vælg de EarTips, der passer bedst til dine ører.



## OPLADNING

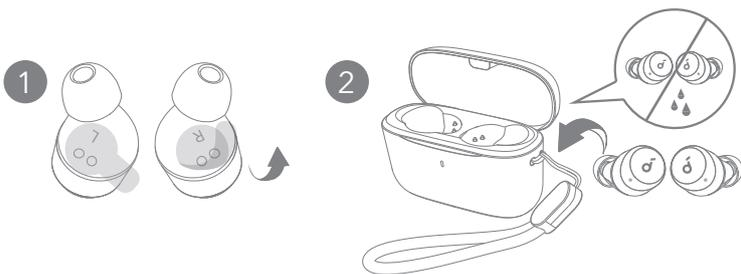

1. Fjern isoleringsmærkatene på ørepropperne, inden de bruges første gang.
2. Placer øretelefonerne i opladeretuiet, og luk det.
  - Tør både øretelefonerne og USB-opladningsporten grundigt af inden opladning.

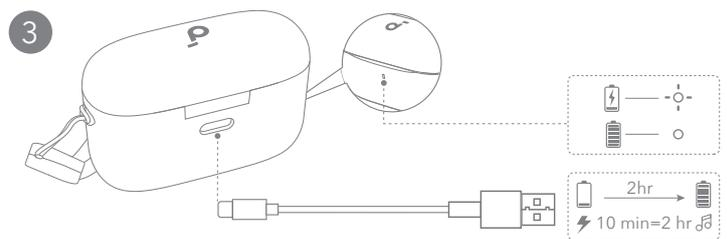

3. Tilslut opladningsetuiet til en strømforsyning ved hjælp af en certificeret USB-C opladningskabel.
  - Oplad både øretelefonerne og opladningsetuiet fuldt ud inden første brug.



## TÆND, OG FORETAG PARRING

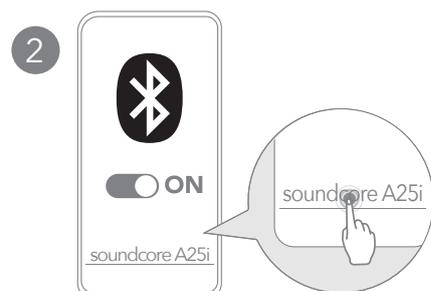
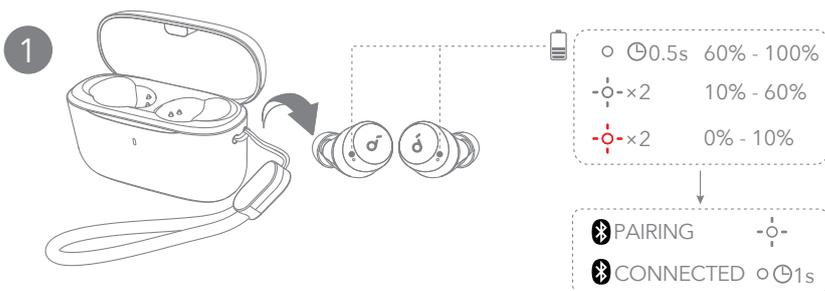

Åbn opladningsetuiet og tag øretelefonerne ud. De tændes automatisk og går i Bluetooth-parringstilstand.

Vælg **"soundcore A20i / A25i"** \* på din enheds Bluetooth-liste, når du tilslutter for første gang.

\*Enhedens navn kan variere afhængigt af regionen.



## MANUEL PARRING

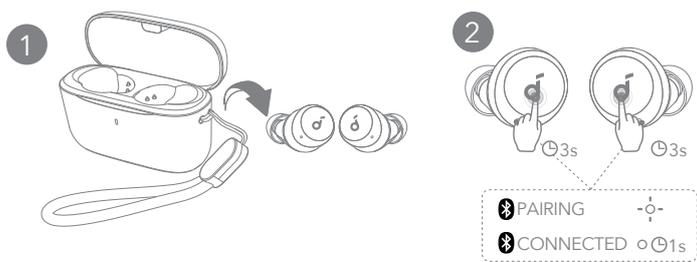

For at indtaste Bluetooth-parringsfunktionen manuelt, skal du tage øretelefonerne ud af etuiet og derefter trykke og holde ned på touchpadsene på begge øretelefoner i 3 sekunder, indtil øretelefonernes LED-indikatorer blinker hurtigt hvidt.



## BETJENINGSKNAPPER

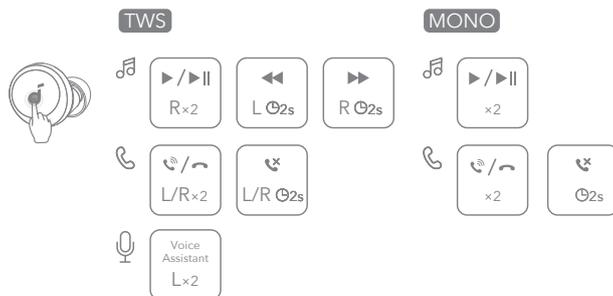

Du kan også tilpasse betjeningsknapperne i soundcore-appen.



## BETJENINGSKNAPPER

	TWS-tilstand	Monotilstand
Afspil / pause	Tryk to gange (H)	Tryk to gange
Forrige nummer	Tryk og hold nede i 2 sekunder (V)	/
Næste nummer	Tryk og hold nede i 2 sekunder (H)	/
Besvar / afslut et opkald	Tryk to gange (V/H)	Tryk to gange
Afvis et opkald	Tryk og hold i 2 sekunder (V/H)	Tryk og hold nede i 2 sekunder
Aktiver softwaren for stemmeassistance	Tryk to gange (V)	/



## SLUK

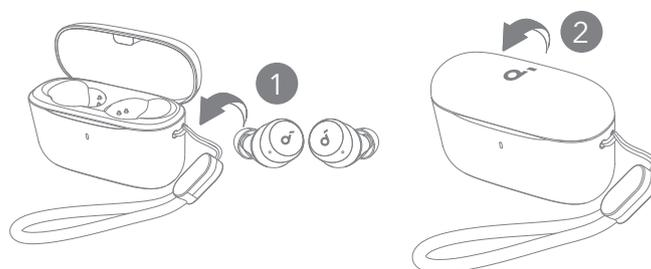

For at slukke skal du sætte øretelefonerne tilbage i opladeretuiet og lukke det. Øretelefonerne vil automatisk slukke efter 30 minutter, hvis de ikke er tilsluttet.



## NULSTIL

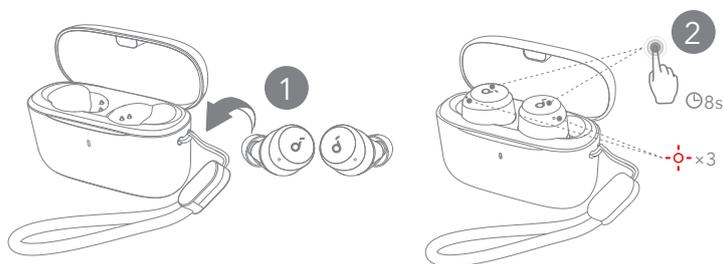

Nulstil, hvis øretelefonerne ikke kan parres med hinanden eller med andre enheder. Placer øretelefonerne i opladningsetuiet og lad etuiet være åbent, tryk og derefter hold ned på touchpadsene på begge øretelefoner i 8 sekunder, indtil øretelefonernes LED-indikatorer blinker rødt hurtigt tre gange.



## VEJLEDNING TIL LED-LYS

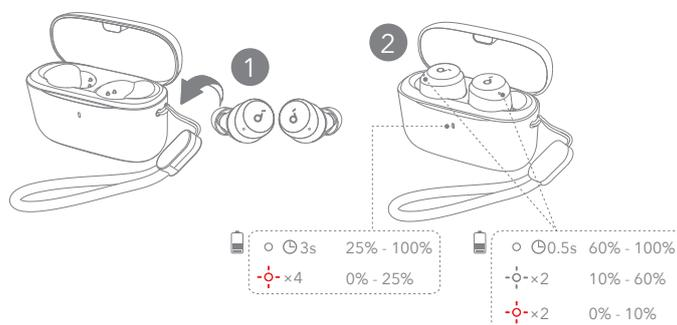

- Konstant hvidt
- Blinker hvidt
- Blinker rødt



## FIRMWARE-OPDATERING

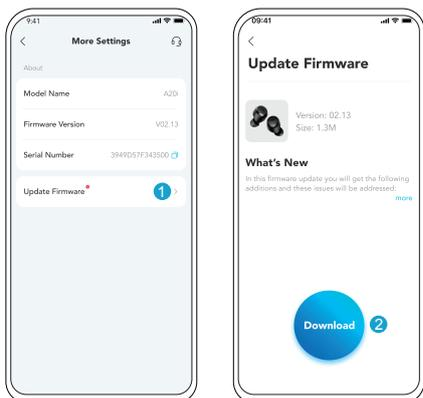

Du vil blive underrettet, når en ny firmware-version opdages, når du tilslutter øretelefonerne til appen. Sørg for, at øretelefonerne er placeret i opladningsetuiet, og at etuiet forbliver åbent, indtil firmwareopdateringen er fuldført. Under opdateringen, sørg for at øretelefonerne oplades og undgå brug af dem.



## SPECIFIKATIONER

Specifikationerne kan ændres uden varsel.

Input	5V $\overline{\text{---}}$ 0.5A
Nominel udgangseffekt	5 mW
Batterikapacitet	60 mAh $\times$ 2 (øretelefoner); 350Ah (opladningsetui)
Opladningstid	Op til 2 timer
Afspilningstid (varierer afhængigt af lydstyrke og indhold)	Op til 9 timer (op til 28 timer med opladningsetuiet)
Driverenhed	6 mm dynamisk driver
Frekvensgang	20 Hz - 20 kHz
Impedans	16 $\Omega$
Vandtæthedsklassifikation (øretelefoner)	IPX5
Bluetooth-version	5.3
Bluetooth-dækning	10 m/33 ft



## APP



Google Play and the Google Play logo are trademarks of Google Inc.



Apple and the Apple logo are trademarks of Apple Inc.



## DAS TRAGEN

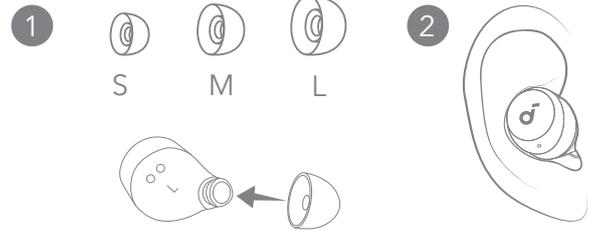

Laden Sie die Soundcore-App herunter, um Ihr Erlebnis zu verbessern (Gaming-Modus, Gerät finden, EQ-Abstimmung, Firmware-Update und mehr).

Wenn Ihre Ohrhörer keine Verbindung mit der soundcore-App herstellen können, aktualisieren Sie sie auf die neueste Version in Ihrem mobilen App-Store.

Wählen Sie die Ohrstöpsel, die am besten zu Ihren Ohren passen.



## LADEN

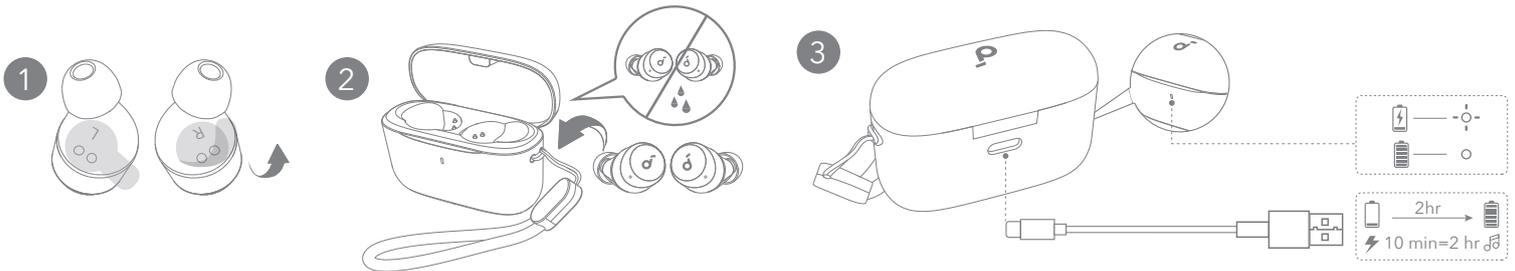

1. Reißen Sie vor dem ersten Gebrauch den Isolieraufkleber von den Ohrhörern ab.
2. Platzieren Sie die Ohrhörer in der Ladeschale und schließen Sie diese.
  - Trocknen Sie die Ohrhörer und den USB-C-Ladeanschluss vor dem Aufladen vollständig ab.

3. Schließen Sie das Ladegehäuse mit einem zertifizierten USB-C-Ladekabel an eine Stromquelle an.
  - Laden Sie sowohl die Ohrhörer als auch das Ladegehäuse vor dem ersten Gebrauch vollständig auf.



## EINSCHALTEN UND KOPPELN

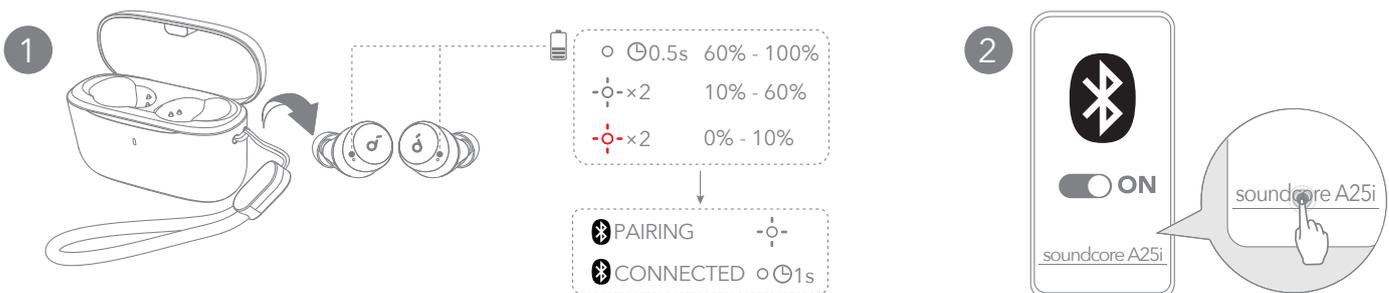

Das Ladegehäuse öffnen und die Ohrhörer herausnehmen. Sie werden automatisch eingeschaltet und wechseln in den Bluetooth-Kopplungsmodus.

Wählen Sie **"soundcore A20i / A25i"** \* in der Bluetooth-Liste Ihres Geräts aus, wenn Sie zum ersten Mal eine Verbindung herstellen. \* Der Gerätenamen kann je nach Region variieren.



# MANUELLES KOPPELN

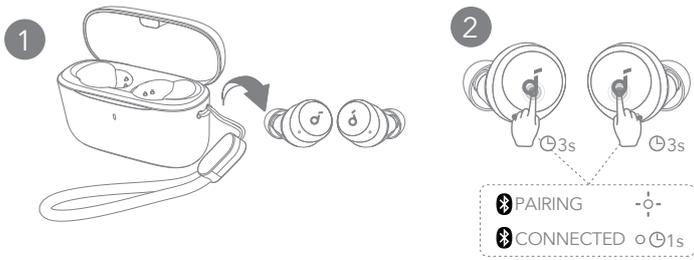

Um den Bluetooth-Kopplungsmodus manuell zu aktivieren, nehmen Sie die Ohrhörer aus der Hülle und tippen und halten Sie dann die Touchpads an beiden Ohrhörern 3 Sekunden lang gedrückt, bis die LED-Anzeigen der Ohrhörer schnell weiß blinken.



# BEDIENELEMENTE

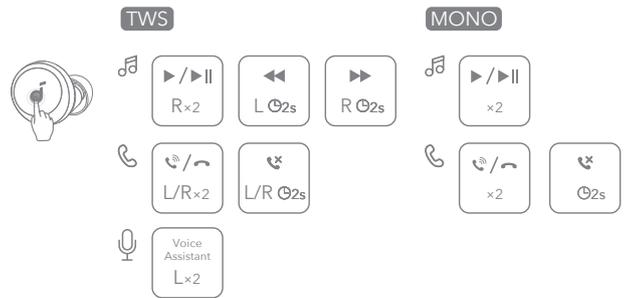

Sie können die Bedienelemente auch über die Soundcore-App anpassen.



# BEDIENELEMENTE

	TWS-Modus	Mono-Modus
Wiedergabe/Pause	Zweimal tippen (R)	Zweimal tippen
Vorheriger Titel	2 Sekunden lang gedrückt halten (L)	/
Nächster Titel	2 Sekunden lang gedrückt halten (R)	/
Einen Anruf annehmen/beenden	Zweimal tippen (L/R)	Zweimal tippen
Anruf ablehnen	Für 2 Sekunden gedrückt halten (L/R)	2 Sekunden lang gedrückt halten
Sprachassistent-Software aktivieren	Zweimal tippen (L)	/



# EINSCHALTEN

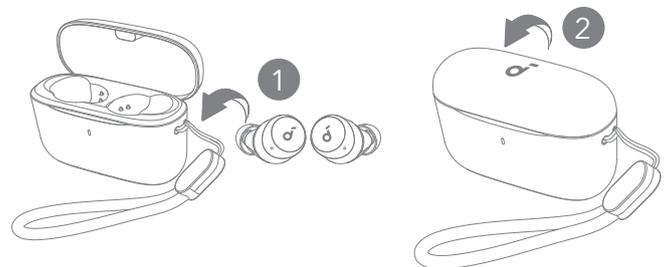

Legen Sie die Ohrhörer zum Ausschalten in die Ladeschale und schließen Sie diese. Die Ohrhörer schalten sich automatisch nach 30 Minuten aus, wenn sie nicht verbunden sind.



# ZURÜCKSETZEN

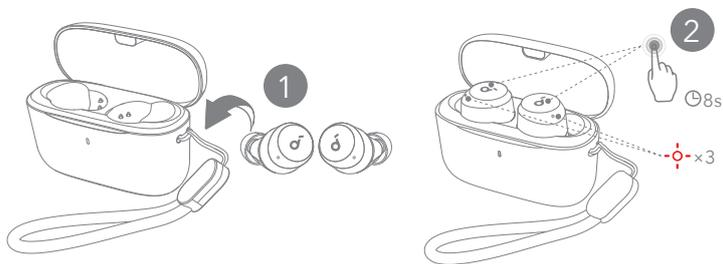

Setzen Sie die Ohrhörer zurück, wenn sie nicht miteinander oder mit anderen Geräten gekoppelt werden können. Legen Sie die Ohrhörer in das Ladegehäuse und lassen Sie das Gehäuse offen, tippen und halten Sie dann die Touchpads an beiden Ohrhörern 8 Sekunden lang, bis die LED-Anzeigen der Ohrhörer dreimal schnell rot blinken.



# ANLEITUNG ZU LED-ANZEIGEN

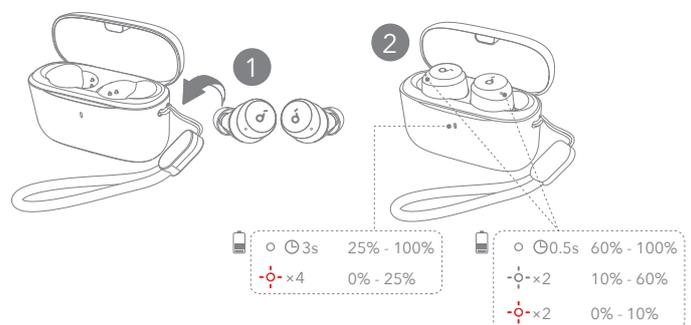

- Leuchtet weiß
- Blinkt weiß
- Blinkt rot



## FIRMWARE- AKTUALISIERUNG

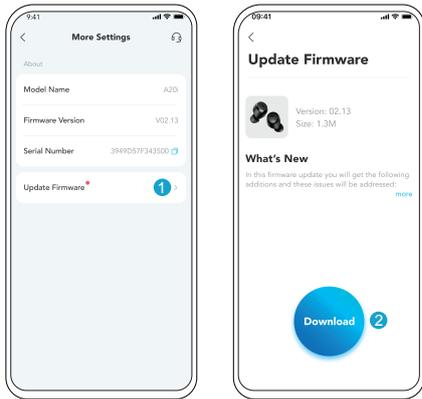

Sie werden benachrichtigt, sobald eine neue Firmware-Version erkannt wird, wenn Sie die Ohrhörer mit der App verbinden. Stellen Sie sicher, dass die Ohrhörer in der Ladehülle platziert sind und die Hülle geöffnet bleibt, bis das Firmware-Update abgeschlossen ist. Während des Updates stellen Sie sicher, dass die Ohrhörer aufgeladen werden und vermeiden Sie jegliche Verwendung.



## TECHNISCHE DATEN

Änderungen der technischen Daten sind ohne Vorankündigung vorbehalten.

Leistungsaufnahme	5V $\overline{\text{---}}$ 0.5A
Nennausgangsleistung	5 mW
Akkukapazität	60 mAh x 2 (Ohrhörer); 350Ah (Ladehülle)
Ladedauer	Bis zu 2 Stunden
Wiedergabedauer (je nach Lautstärke und Inhalt)	Bis zu 9 Stunden (bis zu 28 Stunden mit der Ladehülle)
Treibereinheit	6mm dynamischer Treiber
Frequenzgang	20 Hz - 20 kHz
Impedanz	16 $\Omega$
Wasserdichtigkeit (Ohrhörer)	IPX5
Bluetooth-Version	5.3
Bluetooth-Reichweite	10 m



## ΕΦΑΡΜΟΓΗ



Google Play and the Google Play logo are trademarks of Google Inc.



Apple and the Apple logo are trademarks of Apple Inc.



Κατεβάστε την εφαρμογή soundcore για να βελτιώσετε την εμπειρία σας (λειτουργία παιχνιδιού, εύρεση συσκευής, ρύθμιση ισορροπίας ήχου, ενημέρωση υλικολογισμικού και πολλά άλλα). Εάν τα ακουστικά σας δεν μπορούν να συνδεθούν με την εφαρμογή soundcore, ενημερώστε την στην πιο πρόσφατη έκδοση στο κατάστημα εφαρμογών για κινητά τηλέφωνα.



## ΧΡΗΣΗ

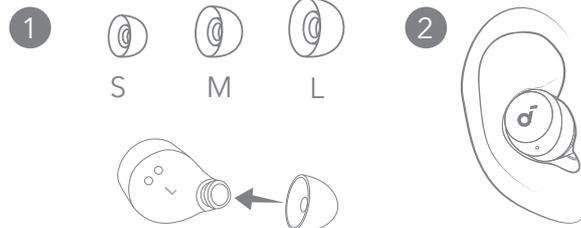

Επιλέξτε τα βύσματα που ταιριάζουν καλύτερα στα αυτιά σας.



## ΦΟΡΤΙΣΗ

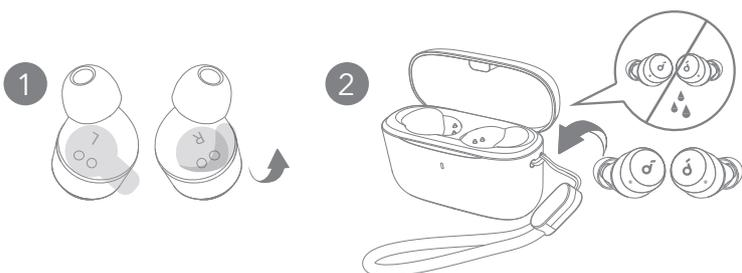

1. Αφαιρέστε το αυτοκόλλητο μόνωσης στα ακουστικά πριν από την πρώτη χρήση.
2. Τοποθετήστε τα ακουστικά μέσα στη θήκη φόρτισης και κλείστε την.
  - Στεγνώστε τελείως τα ακουστικά και τη θύρα φόρτισης USB-C, πριν από τη φόρτιση.

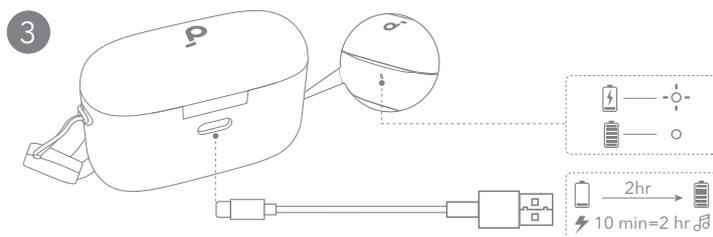

3. Συνδέστε τη θήκη φόρτισης σε μια πηγή τροφοδοσίας χρησιμοποιώντας ένα πιστοποιημένο καλώδιο φόρτισης USB-C.
  - Φορτίστε πλήρως και τα δύο ακουστικά και τη θήκη φόρτισης πριν την πρώτη χρήση.

## ΕΝΕΡΓΟΠΟΙΗΣΗ & ΣΥΖΕΥΞΗ

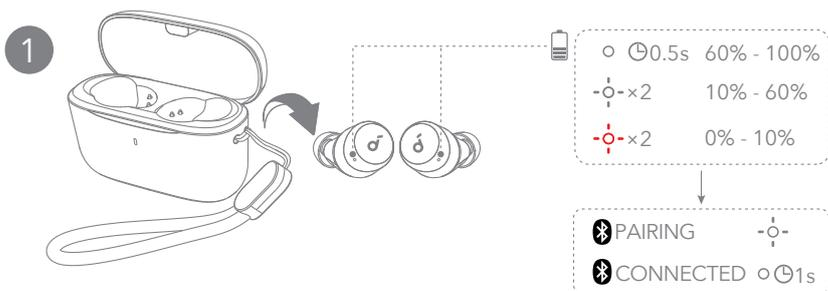

Ανοίξτε τη θήκη φόρτισης και βγάλτε τα ακουστικά. Θα ενεργοποιηθούν αυτόματα και θα μεταβούν στη λειτουργία σύζευξης μέσω Bluetooth.

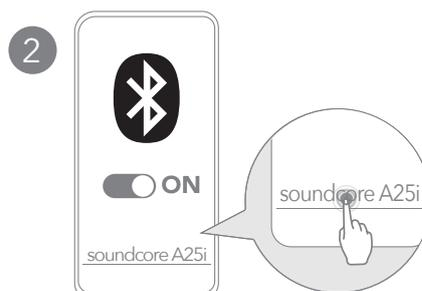

Επιλέξτε το **"soundcore A20i / A25i"** \* από τη λίστα Bluetooth της συσκευής σας κατά τη σύνδεση για πρώτη φορά.

\* Το όνομα της συσκευής ενδέχεται να διαφέρει ανάλογα με την περιοχή.



## ΧΕΙΡΟΚΙΝΗΤΗ ΣΥΖΕΥΞΗ

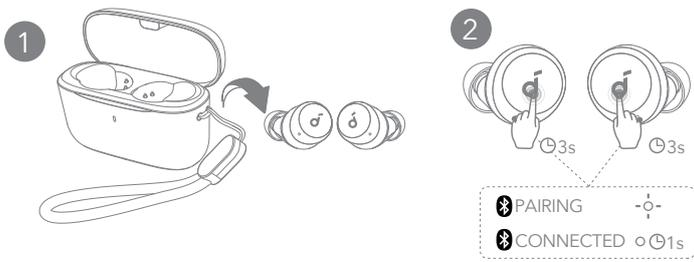

Για να εισέλθετε χειροκίνητα στη λειτουργία σύζευξης Bluetooth, βγάλτε τα ακουστικά από τη θήκη, και στη συνέχεια πατήστε και κρατήστε τα touchpads στα δύο ακουστικά για 3 δευτερόλεπτα μέχρι οι δείκτες LED των ακουστικών να αναβοσβήνουν γρήγορα σε λευκό χρώμα.



## ΣΤΟΙΧΕΙΑ ΕΛΕΓΧΟΥ

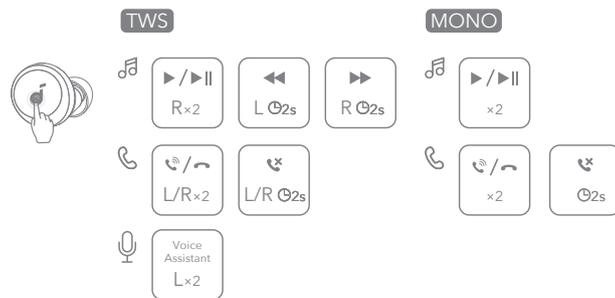

Μπορείτε επίσης να προσαρμόσετε τα στοιχεία ελέγχου στην εφαρμογή soundcore.



## ΣΤΟΙΧΕΙΑ ΕΛΕΓΧΟΥ

	Λειτουργία TWS	Λειτουργία μονοφωνικού ήχου	
	Αναπαραγωγή/Παύση	Πατήστε δύο φορές το (R).	Πατήστε δύο φορές.
	Προηγούμενο κομμάτι	Πιέστε παρατεταμένα το (L) για 2 δευτερόλεπτα	/
	Επόμενο κομμάτι	Πιέστε παρατεταμένα το (R) για 2 δευτερόλεπτα	/
	Απάντηση/Τερματισμός κλήσης	Πατήστε δύο φορές το (L/R).	Πατήστε δύο φορές.
	Απόρριψη κλήσης	Πατήστε παρατεταμένα το (L/R) επί 2 δευτερόλεπτα.	Πιέστε παρατεταμένα για 2 δευτερόλεπτα
	Ενεργοποίηση του λογισμικού φωνητικής υποβοήθησης	Πατήστε δύο φορές το (L).	/



## ΑΠΕΝΕΡΓΟΠΟΙΗΣΗ

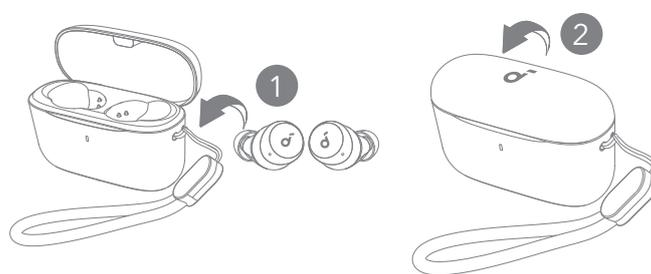

Για απενεργοποίηση, τοποθετήστε τα ακουστικά ξανά μέσα στη θήκη φόρτισης και κλείστε την. Τα ακουστικά θα απενεργοποιηθούν αυτόματα μετά από 30 λεπτά αν δεν είναι συνδεδεμένα.



## ΕΠΑΝΑΦΟΡΑ

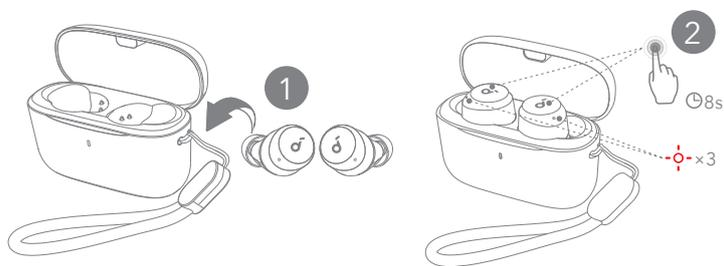

Πραγματοποιήστε επαναφορά, εάν δεν επιτυγχάνεται σύζευξη των ακουστικών σωστά μεταξύ τους ή με άλλες συσκευές. Τοποθετήστε τα ακουστικά στο κουτί φόρτισης και αφήστε το κουτί ανοιχτό, στη συνέχεια πατήστε και κρατήστε τα touchpads στα δύο ακουστικά για 8 δευτερόλεπτα μέχρι οι δείκτες LED των ακουστικών να αναβοσβήνουν σε κόκκινο χρώμα τρεις φορές γρήγορα.



## ΟΔΗΓΟΣ ΦΩΤΙΣΜΟΥ LED

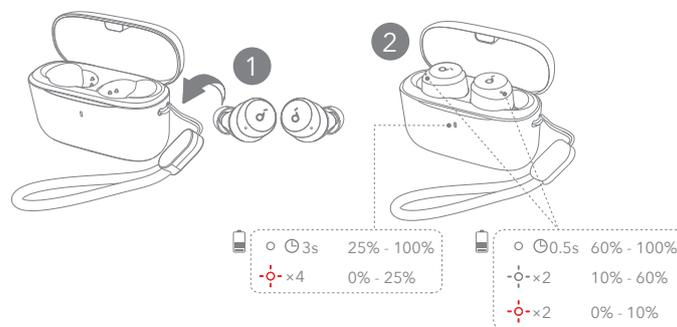

- Μένει συνεχώς αναμμένος σε λευκό χρώμα.
- ⊖ Αναβοσβήνει γρήγορα σε λευκό χρώμα.
- ⊖x Αναβοσβήνει γρήγορα σε κόκκινο χρώμα.

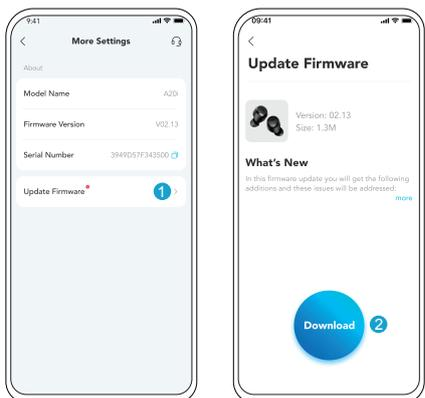

Θα ενημερωθείτε μόλις ανιχνευθεί μια νέα έκδοση υλικολογισμικού όταν συνδέσετε τα ακουστικά στην εφαρμογή. Βεβαιωθείτε ότι τα ακουστικά είναι τοποθετημένα στη θήκη φόρτισης και η θήκη παραμένει ανοιχτή μέχρι ολοκληρωθεί η ενημέρωση του υλικολογισμικού. Κατά τη διάρκεια της ενημέρωσης, βεβαιωθείτε ότι τα ακουστικά είναι σε φόρτιση και αποφύγετε οποιαδήποτε χρήση.

Οι προδιαγραφές ενδέχεται να αλλάξουν χωρίς σχετική ειδοποίηση.

Είσοδος	5V --- 0,5A
Ονομαστική ισχύς εξόδου	5 mW
Χωρητικότητα μπαταρίας	60 mAh × 2 (ακουστικά), 350Ah (θήκη φόρτισης)
Διάρκεια φόρτισης	Έως 2 ώρες
Χρόνος αναπαραγωγής (Ποικίλλει ανάλογα με την ένταση του ήχου και το περιεχόμενο.)	Έως 9 ώρες (έως 28 ώρες με τη θήκη φόρτισης)
Μονάδα οδηγού	6mm δυναμικός οδηγός
Απόκριση συχνότητας	20 Hz-20 kHz
Εμπέδηση	16Ω
Επίπεδο υδατοστεγανότητας (ακουστικά)	IPX5
Έκδοση Bluetooth	5.3
Εμβέλεια Bluetooth	10 μέτρα/33 πόδια



# Aplicación



Google Play and the Google Play logo are trademarks of Google Inc.



Apple and the Apple logo are trademarks of Apple Inc.



Descargue la aplicación Soundcore para mejorar su experiencia (modo de juego, encontrar dispositivo, ajuste de EQ, actualización de firmware y más).

Si los auriculares no pueden conectarse a través de la aplicación soundcore, actualícela a la última versión en su tienda de aplicaciones móviles.



# MODO DE USO

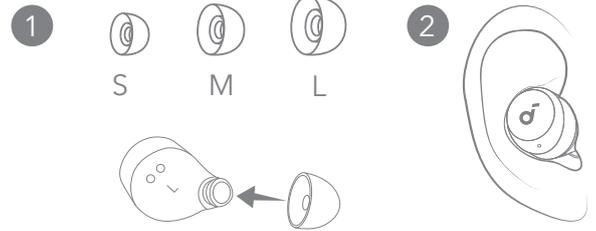

Escoja las almohadillas que mejor se adapten a sus oídos.



# CARGA

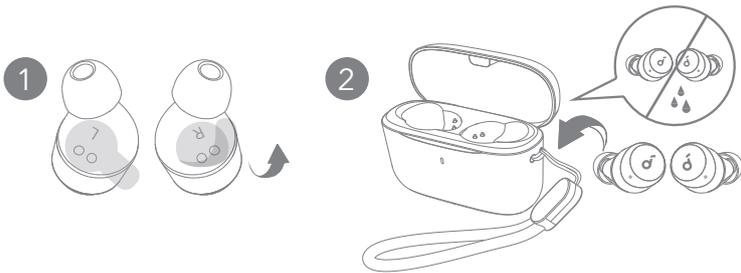

1. Quite la etiqueta protectora de los auriculares antes de usarlos por primera vez.
2. Coloque los auriculares en el estuche de carga y ciérralo.
  - Seque bien los auriculares y el puerto de carga USB antes de realizar la carga.

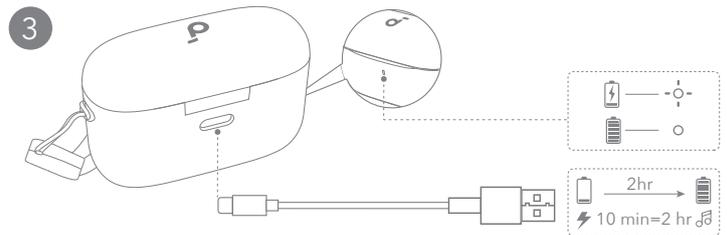

3. Conecte el estuche de carga a una fuente de alimentación utilizando un cable de carga USB-C certificado.
  - Cargue completamente tanto los auriculares como el estuche de carga antes del primer uso.

# ENCENDIDO Y EMPAREJAMIENTO

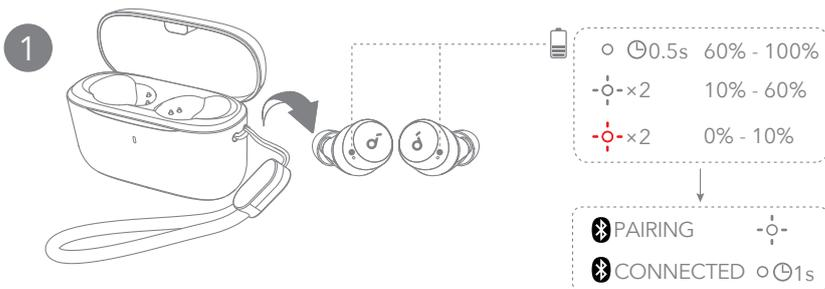

Abra el estuche de carga y saque los auriculares. Se encenderán automáticamente y se activará el modo de emparejamiento por Bluetooth.

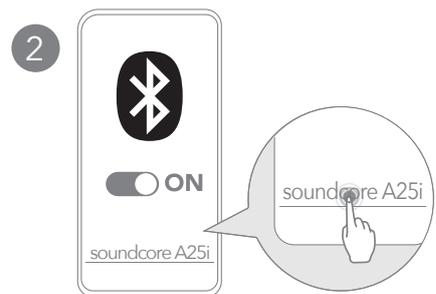

Seleccione **"soundcore A20i / A25i"** \* en la lista de Bluetooth de su dispositivo al conectarse por primera vez.

\*El nombre del dispositivo puede ser diferente según la región.



# EMPAREJAMIENTO MANUAL

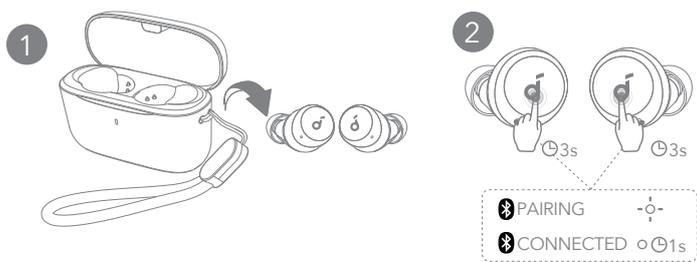

Para entrar manualmente en el modo de emparejamiento de Bluetooth, saque los auriculares del estuche, luego toque y mantenga presionados los paneles táctiles en ambos auriculares durante 3 segundos hasta que los indicadores LED de los auriculares parpadeen rápidamente en blanco.



# CONTROLES

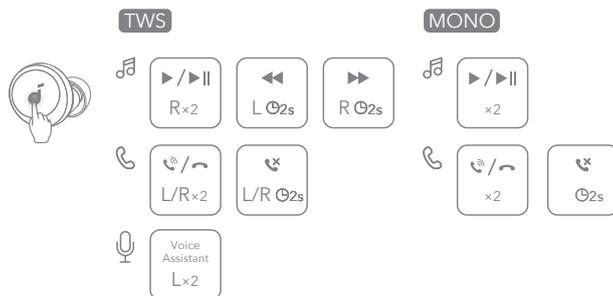

También puede personalizar los controles en la aplicación soundcore.



# CONTROLES

	Modo TWS	Modo mono
Reproducir/Pausar	Pulsar dos veces (R)	Tocar dos veces
Canción anterior	Tocar y mantener pulsado durante 2 segundos (L)	/
Canción siguiente	Tocar y mantener pulsado durante 2 segundos (R)	/
Responder/Terminar una llamada	Pulsar dos veces (L/R)	Tocar dos veces
Rechazar una llamada	Mantener pulsado durante 2 segundo(s) (L/R)	Tocar y mantener pulsado durante 2 segundos
Activar el software del asistente de voz	Pulsar dos veces (L)	/



# CÓMO APAGARLOS

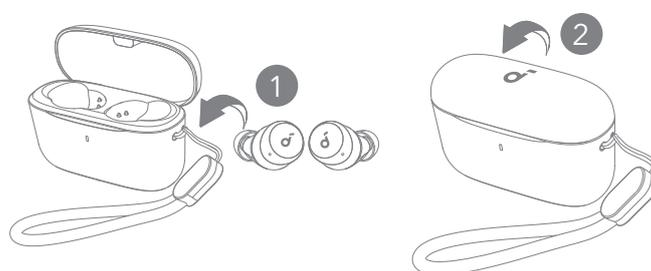

Para apagarlos, vuelva a ponerlos en el estuche de carga y ciérrelo. Los auriculares se apagarán automáticamente después de 30 minutos si no están conectados.



# REINICIO

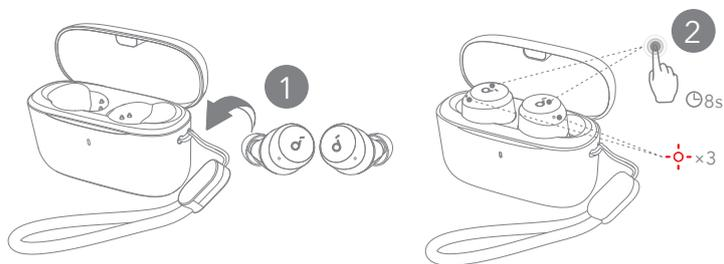

Reinicie los auriculares si hay problemas de emparejamiento entre sí o con otros dispositivos. Coloque los auriculares en el estuche de carga y deje el estuche abierto. Luego toque y mantenga presionados los paneles táctiles en ambos auriculares durante 8 segundos hasta que los indicadores LED de los auriculares parpadeen rápidamente tres veces en rojo.



# GUÍA DE LUZ LED

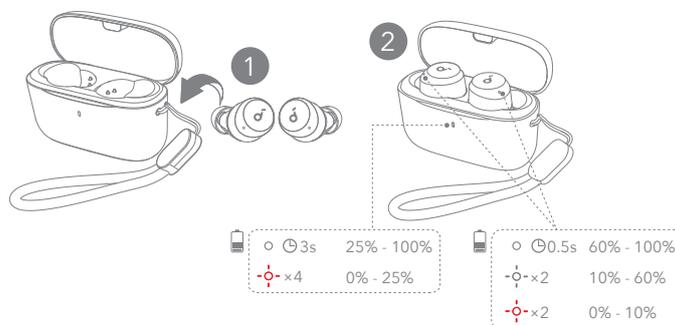

- Blanco fijo
- ◌-◌ Blanco intermitente
- ◌-◌ Rojo intermitente



## ACTUALIZACIÓN DE FIRMWARE

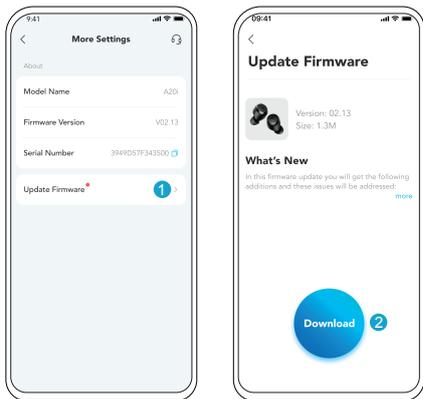

Será notificado una vez que se detecte una nueva versión del firmware cuando conecte los auriculares a la aplicación. Asegúrese de que los auriculares estén colocados en la caja de carga y que la caja permanezca abierta hasta que se complete la actualización del firmware. Durante la actualización, asegúrese de que los auriculares estén cargándose y evite utilizarlos de cualquier forma.



## ESPECIFICACIONES

Las especificaciones están sujetas a cambios sin previo aviso.

Entrada	5V $\overline{\text{---}}$ 0.5A
Valor nominal de potencia de salida	5 mW
Capacidad de la batería	60 mAh $\times$ 2 (auriculares); 350Ah (estuche de carga)
Tiempo de carga	Hasta 2 horas
Tiempo de reproducción (varía en función del nivel de volumen y el contenido)	Hasta 9 horas (hasta 28 horas con el estuche de carga).
Unidad de controlador	Controlador dinámico de 6mm.
Respuesta de frecuencia	20 Hz-20 kHz
Impedancia	16 $\Omega$
Clasificación de resistencia al agua (auriculares)	IPX5
Versión de Bluetooth	5.3
Alcance de Bluetooth	10 m



## SOVELLUS



Google Play and the Google Play logo are trademarks of Google Inc.



Apple and the Apple logo are trademarks of Apple Inc.



## KÄYTTÖ

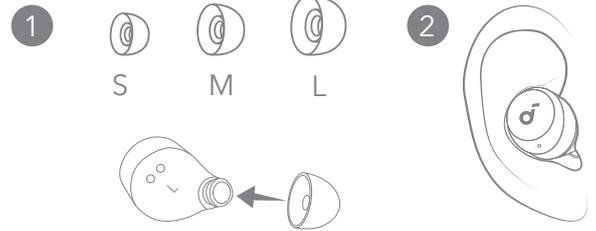

Lataa Soundcore-sovellus parantaaksesi kokemustasi (pelitila, laitteen etsiminen, EQ-viritys, laiteohjelmistopäivitys ja paljon muuta). Jos nappikuulokkeet eivät voi muodostaa yhteyttä soundcore-sovellukseen, päivitä se uusimpaan versioon mobiilisovelluskaupassasi.

Valitse korviisi parhaiten sopivat EarTips-korvasovitteet.



## KÄYTTÖ

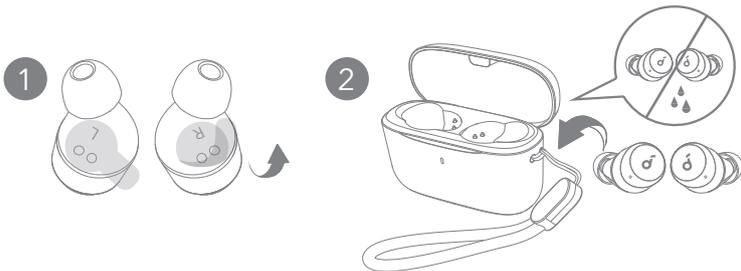

1. Repäise irti nappikuulokkeiden eristystarra ennen ensimmäistä käyttöä.
2. Aseta nappikuulokkeet latauskoteloon ja sulje se.
  - Kuivaa nappikuulokkeet ja USB-C-latausportti täysin kuiviksi ennen lataamista.

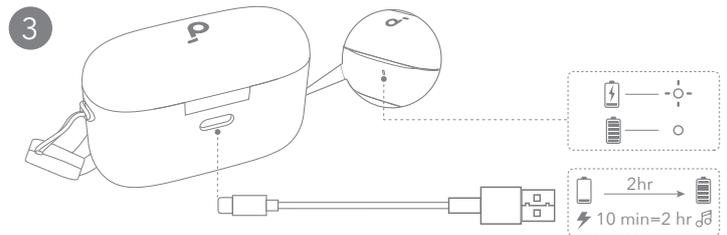

3. Liitä latauskotelo sertifioidulla USB-C-latauskaapelilla virtalähteeseen.
  - Lataa molemmat nappikuulokkeet ja latauskotelo täyteen ennen ensimmäistä käyttöä.



## VIRRAN KYTKEMINEN JA LAITEPARIN MUODOSTAMINEN

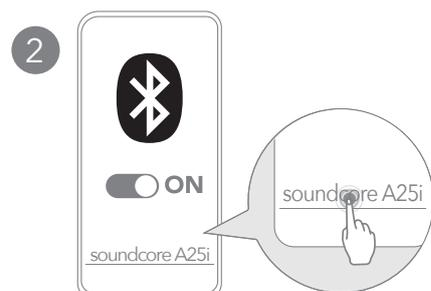
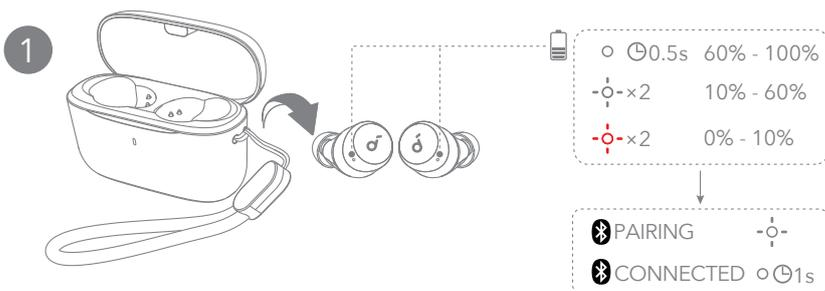

Avaa latauskotelo ja ota nappikuulokkeet ulos. Ne kytkeytyvät automaattisesti päälle ja siirtyvät Bluetooth-pariliitostilaan.

Valitse **"soundcore A20i / A25i"** \* laitteesi Bluetooth-listalta yhdistäessäsi ensimmäistä kertaa.

\*Laitteen nimi voi vaihdella alueen mukaan.



## MANUAALINEN PARILIITOS

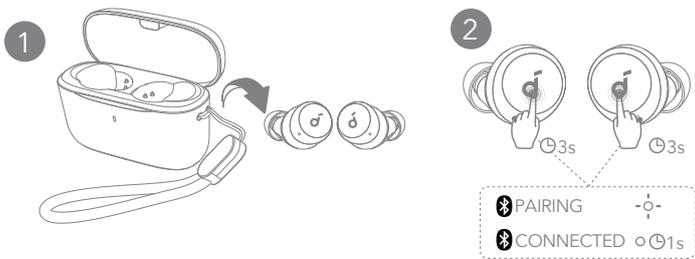

Bluetooth-pariliitostilan manuaalinen käynnistäminen tapahtuu ottamalla nappikuulokkeet kotelosta, jonka jälkeen kosketa ja pidä molemmissa kuulokkeissa olevia kosketuslevyjä 3 sekunnin ajan, kunnes kuulokkeiden LED-merkkivalot vilkkuvat nopeasti valkoisena.



## SÄÄTIMET

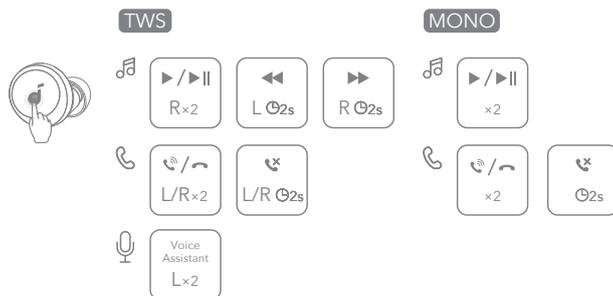

Voit myös mukauttaa säätimiä Soundcore-sovelluksessa.



## SÄÄTIMET

	TWS-tila	Monotila
Toista/keskeytä	Napauta kahdesti (O)	Napauta kahdesti
Edellinen kappale	Napauta ja pidä painettuna kahden sekunnin ajan (V)	/
Seuraava kappale	Napauta ja pidä painettuna kahden sekunnin ajan (O)	/
Vastaa puheluun / Katkaise puhelu	Napauta kahdesti (V/O)	Napauta kahdesti
Hylkää puhelu	Kosketa 2 sekuntia (V/O)	Napauta ja pidä painettuna kahden sekunnin ajan
Äänivastajaohjelmiston aktivointi	Napauta kahdesti (V)	/



## VIRRRAN KATKAISU

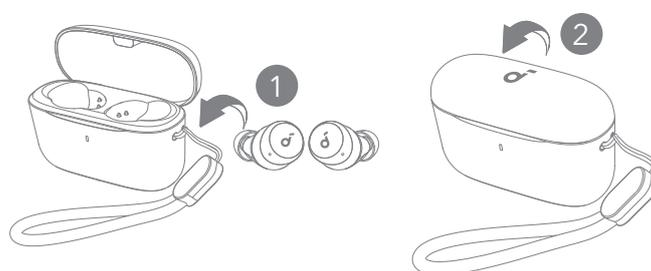

Katkaise virta palauttamalla nappikuulokkeet latauskoteloon ja sulkemalla sen. Kuulokkeet sammuvat automaattisesti 30 minuutin kuluttua, jos ne eivät ole yhdistettyinä.



## NOLLAAMINEN

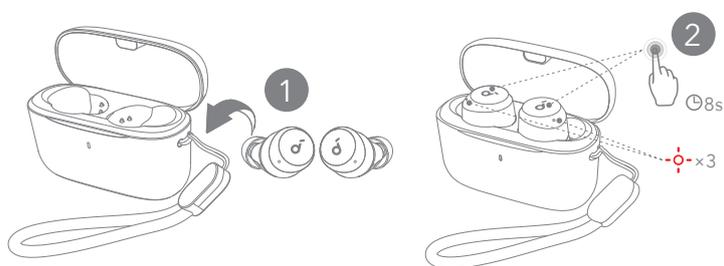

Nollaa, jos esiintyy ongelmia pariitoksen muodostamisessa nappikuulokkeiden kesken tai muiden laitteiden kanssa. Aseta nappikuulokkeet latauskoteloon ja jätä kotelon kansi auki. Napauta ja pidä kosketuslevyjä painettuna molemmissa kuulokkeissa 8 sekunnin ajan, kunnes kuulokkeiden LED-merkkivalot vilkkuvat nopeasti punaisina kolme kertaa.



## LED-VALO-OPAS

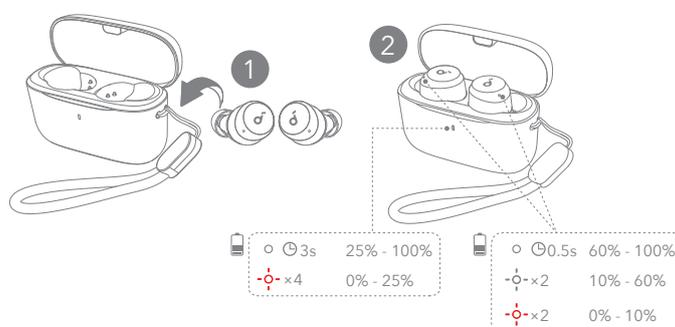

- Tasaisen valkoinen
- ◌-◌- Vilkkuva valkoinen
- ◌-◌- Vilkkuu punaisena

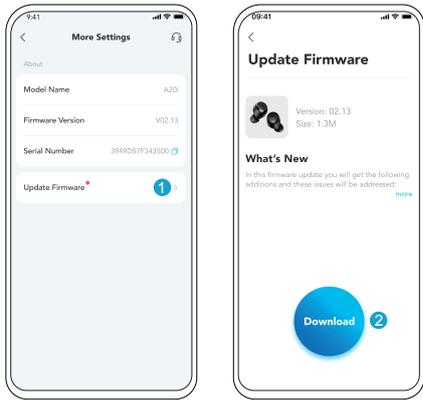

Sinulle ilmoitetaan, kun uusi laiteohjelmistoversio havaitaan, kun yhdistät nappikuulokkeet sovellukseen. Varmista, että nappikuulokkeet ovat latauskotelossa ja kotelon kansi pysyy avoinna, kunnes laiteohjelmiston päivitys on valmis. Päivityksen aikana varmista, että nappikuulokkeita ladataan ja välttä käyttöä.

Tekniset tiedot voivat muuttua ilman erillistä ilmoitusta.

Tulo	5V $\overline{\text{---}}$ 0.5A
Nimellislähtöteho	5 mW
Akun kapasiteetti	60 mAh $\times$ 2 (nappikuulokkeet); 350 Ah (latauskotelo)
Latausaika	Jopa 2 tuntia
Toisto-aika (vaihtelee äänenvoimakkuuden ja toistettavan sisällön mukaan)	Jopa 9 tuntia (jopa 28 tuntia latauskotelon kanssa)
Kaiutinelementtiyksikkö	6 mm dynaaminen ajuri
Taajuusvaste	20 Hz - 20 kHz
Impedanssi	16 $\Omega$
Vedenpitävyysluokitus (nappikuulokkeet)	IPX5
Bluetooth-versio	5.3
Bluetoothin kantomatka	10 m



## APPLICATION



Google Play and the Google Play logo are trademarks of Google Inc.



Apple and the Apple logo are trademarks of Apple Inc.



Téléchargez l'application Soundcore pour améliorer votre expérience (mode Gaming, Trouver l'appareil, Réglage EQ, Mise à jour du firmware, et plus encore).

Si vos écouteurs ne peuvent pas se connecter à l'application soundcore, mettez-la à jour dans la dernière version disponible dans votre magasin d'applications mobiles.



## UTILISATION

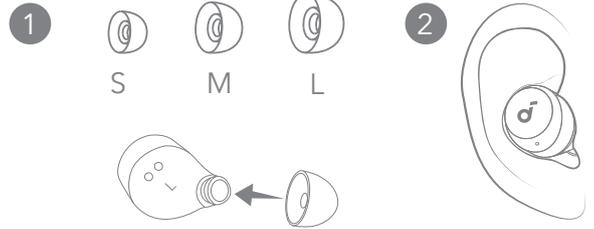

Choisissez les embouts les mieux adaptés à vos oreilles.



## CHARGEMENT

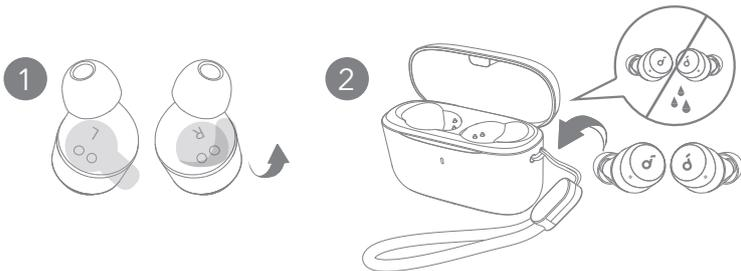

1. Détachez l'autocollant d'isolation des écouteurs avant la première utilisation.
2. Placez les écouteurs dans le boîtier de charge et fermez ce dernier.
  - Séchez entièrement les écouteurs et le port de charge USB-C avant la charge.

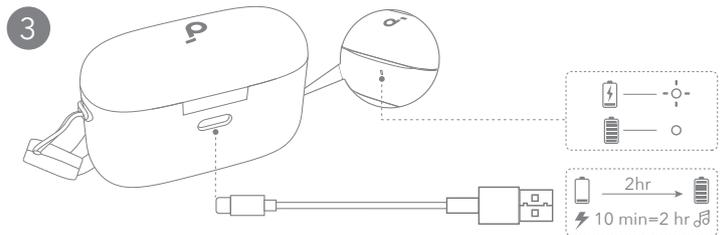

3. Connectez le boîtier de charge à une source d'alimentation en utilisant un câble de charge USB-C certifié.
  - Chargez complètement les deux écouteurs et le boîtier de charge avant la première utilisation.

## MISE SOUS TENSION ET COUPLAGE

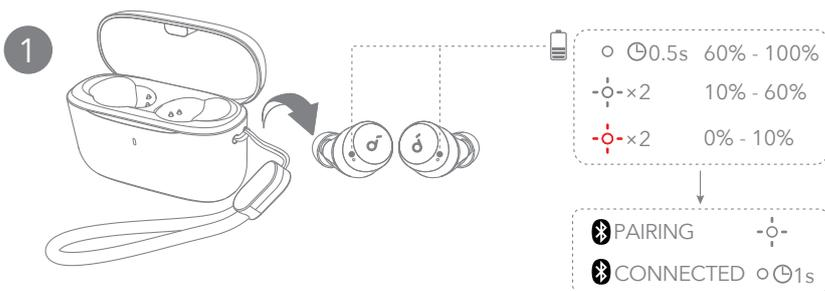

Ouvrez l'étui de chargement et sortez les écouteurs. Elles s'allumeront automatiquement et entreront en mode d'appariement Bluetooth.

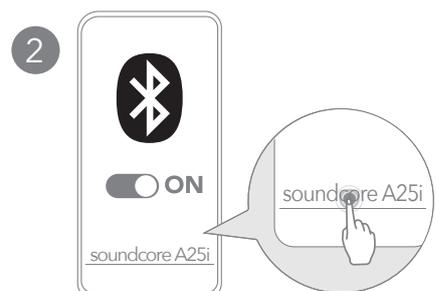

Sélectionnez « **soundcore A20i / A25i** » \* dans la liste Bluetooth de votre appareil lors de la première connexion.

\*Le nom de l'appareil peut varier selon la région.

# COUPLAGE MANUEL

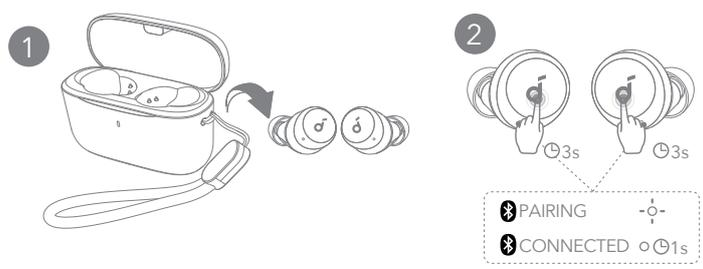

Pour entrer manuellement en mode de couplage Bluetooth, sortez les écouteurs de leur boîtier, puis appuyez et maintenez les pavés tactiles des deux écouteurs pendant 3 secondes jusqu'à ce que les indicateurs LED des écouteurs clignotent rapidement en blanc.

# COMMANDES

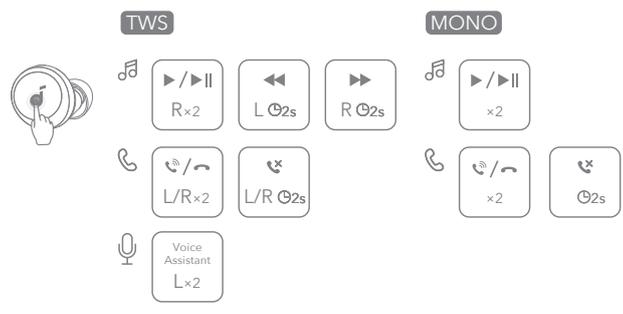

Vous pouvez également personnaliser les commandes dans l'application soundcore.

# COMMANDES

	Mode TWS	Mode mono
Lecture/pause	Appuyer deux fois (D)	Appuyer deux fois
	Maintenir enfoncé pendant 2 secondes (L)	/
	Maintenir enfoncé pendant 2 secondes (R)	/
Répondre à un appel/raccrocher	Appuyer deux fois (G/D)	Appuyer deux fois
	Appuyer et maintenir pendant 2 secondes (G/D)	Maintenir enfoncé pendant 2 secondes
Refuser un appel	Appuyer et maintenir pendant 2 secondes (G/D)	Maintenir enfoncé pendant 2 secondes
Activer le logiciel d'assistant vocal	Appuyer deux fois (G)	/

# MISE HORS TENSION

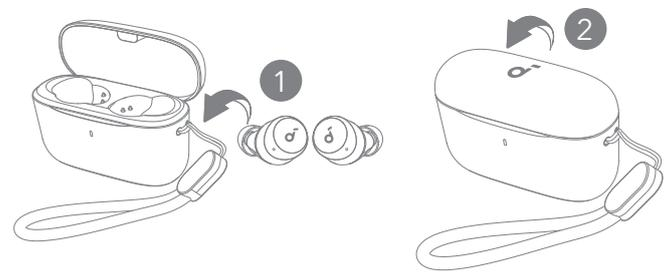

Pour éteindre les écouteurs, placez-les dans l'étui de charge et fermez ce dernier. Les écouteurs s'éteindront automatiquement après 30 minutes s'ils ne sont pas connectés.

# RÉINITIALISATION

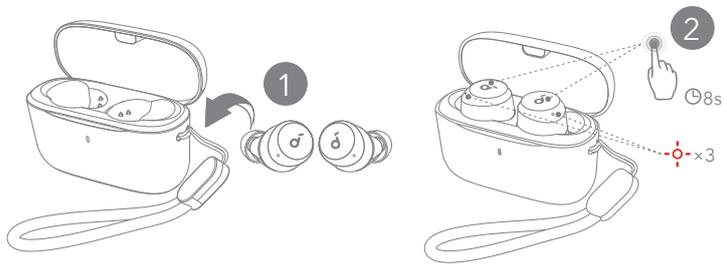

Effectuez une réinitialisation si les écouteurs présentent des problèmes de couplage entre eux ou avec d'autres appareils. Placez les écouteurs dans le boîtier de charge et laissez le boîtier ouvert, puis appuyez et maintenez les pavés tactiles des deux écouteurs pendant 8 secondes jusqu'à ce que les indicateurs LED des écouteurs clignotent rapidement en rouge trois fois.

# SIGNIFICATION DES VOYANTS

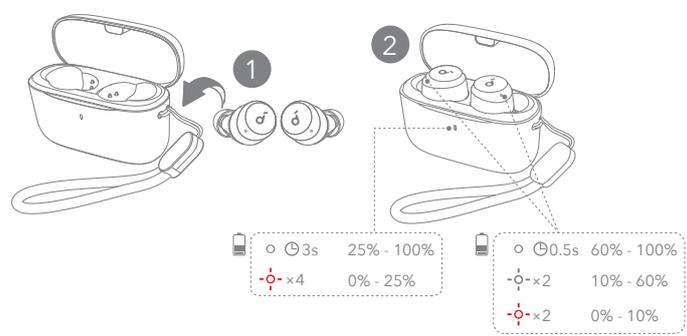

- Blanc fixe
- Blanc clignotant
- Rouge clignotant

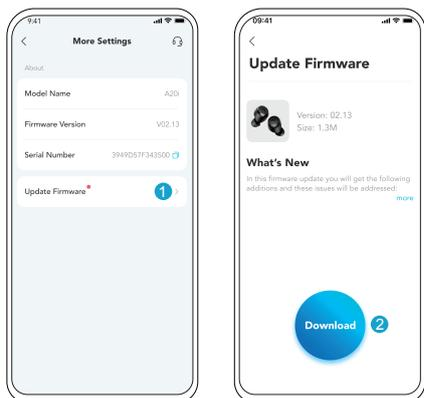

Vous serez informé dès qu'une nouvelle version de firmware sera détectée lorsque vous connecterez les écouteurs à l'application. Assurez-vous que les écouteurs sont placés dans le boîtier de charge et que l'étui reste ouvert jusqu'à ce que la mise à jour du firmware soit terminée. Pendant la mise à jour, assurez-vous que les écouteurs sont en train de charger et évitez toute utilisation.

Les spécifications sont susceptibles d'être modifiées sans préavis.

Entrée	5V  0,5A
Puissance de sortie nominale	5 mW
Capacité de la batterie	60 mAh × 2 (écouteurs) ; 350 Ah (boîtier de charge)
Temps de charge	Jusqu'à 2 heures
Durée de lecture (varie en fonction du niveau sonore et du contenu)	Jusqu'à 9 heures (jusqu'à 28 heures avec l'étui de chargement)
Unité de conduit	Pilote dynamique de 6 mm.
Réponse de fréquence	20 Hz - 20 kHz
Impédance	16Ω
Niveau d'étanchéité (écouteurs)	IPX5
Version Bluetooth	5.3
Portée Bluetooth	10 m / 33 pieds



## APP



Google Play and the Google Play logo are trademarks of Google Inc.



Apple and the Apple logo are trademarks of Apple Inc.



## HASZNÁLAT

1



2

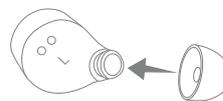

Töltse le a Soundcore alkalmazást, hogy még jobb élményben lehessen része (Játék mód, Eszközkeresés, EQ hangolás, Firmware frissítés és még sok más).

Ha a fülhallgató nem tud csatlakozni a soundcore alkalmazáshoz, frissítse azt a legújabb verzióra a mobilalkalmazás-áruházban.

Válassza ki a füléhez legjobban illeszkedő fülhallgatóbetétet.



## TÖLTÉS

1

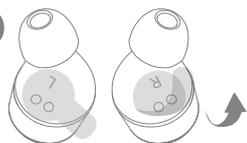

2

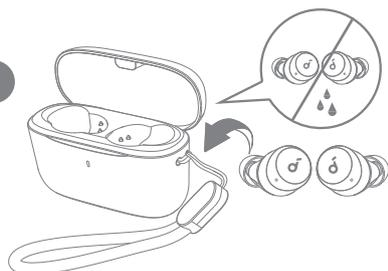

3

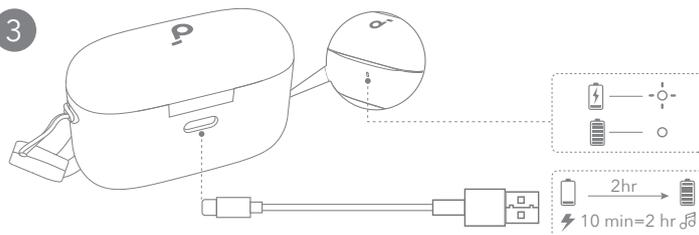

1. Az első használat előtt szakítsa le a fülugó szigetelő matricáját.
2. Helyezze a fülhallgató mindkét részét a töltőtokba, és csukja be a tok fedelét.
- A töltés megkezdése előtt gondosan szárítsa meg a fülhallgató mindkét oldalát és az USB-C töltőportot.

3. Csatlakoztassa a töltőtokot egy tápegységhez egy hitelesített USB-C töltőkábellel.
- Töltse fel teljesen mind a fülhallgatókat, mind a töltőtokot az első használat előtt.



## BEKAPCSOLÁS ÉS PÁROSÍTÁS

1

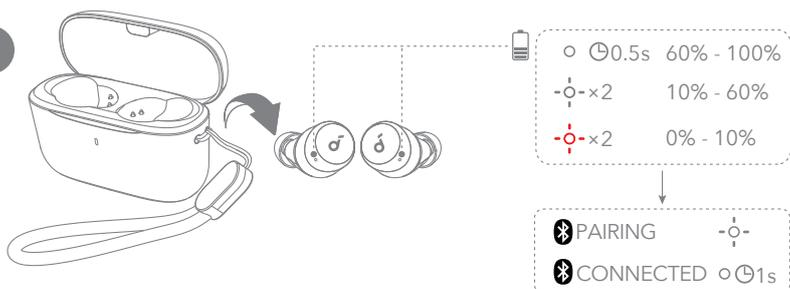

2

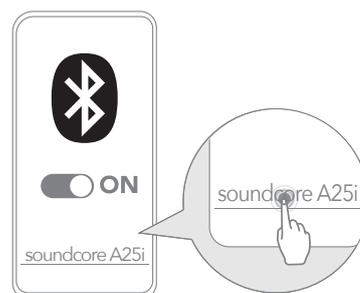

Nyissa ki a töltőtokot és vegye ki a fülhallgatókat. Az eszköz automatikusan bekapcsol, és Bluetooth-párosítási módba lép.

Válassza ki a **"soundcore A20i / A25i"** \* lehetőséget az eszköz Bluetooth listáján, amikor először csatlakozik.

\*Az eszköz neve régióként változhat.



## KÉZI PÁROSÍTÁS

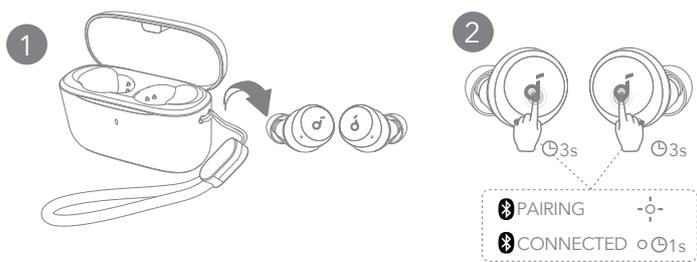

A Bluetooth párosítási módba való kézi belépéshez vegye ki a fülhallgatókat a tokból, majd érintse meg és tartsa lenyomva mindkét fülhallgató érintőfelületét 3 másodpercig, amíg a fülhallgatók LED kijelzői gyorsan fehéren villognak.



## VEZÉRLŐK

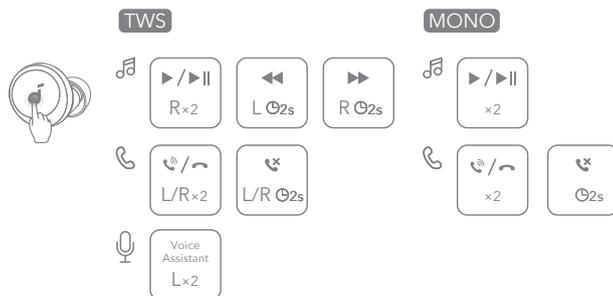

A soundcore alkalmazásban testre is szabhatja a vezérlőket.



## VEZÉRLŐK

	TWS mód	Mono üzemmód
	Lejátszás/megállítás	Dupla koppintás (J)
	Előző szám	Tartsa lenyomva 2 másodpercig (B)
	Következő szám	Tartsa lenyomva 2 másodpercig (J)
	Hívás fogadása/befejezése	Dupla koppintás (J/B)
	Hívás elutasítása	Koppintson, és tartsa nyomva 2 másodpercig (J/B)
	A hangsegédsoftver aktiválása	Dupla koppintás (B)



## KIKAPCSOLÁS

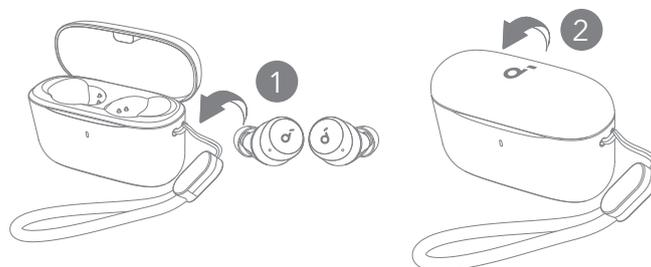

A kikapcsoláshoz helyezze vissza a fülhallgatókat a töltőtokba, és zárja le azt. A fülhallgató automatikusan kikapcsol 30 perc után, ha nincs csatlakoztatva.



## VISSZAÁLLÍTÁS

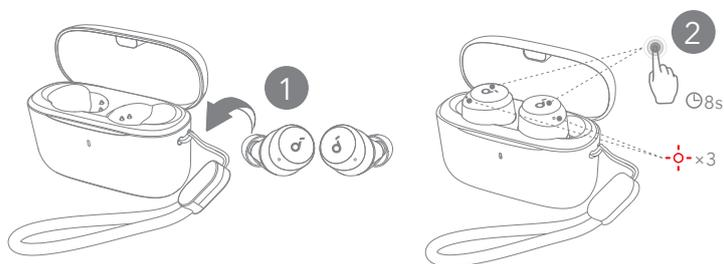

Ha a fülhallgatók egymáshoz vagy más eszközökhöz való csatlakoztatásakor problémába ütközik, állítsa őket alaphelyzetbe. Tegye a fülhallgatókat a töltőtokba, és hagyja nyitva a tokot, majd érintse meg és tartsa lenyomva mindkét fülhallgató érintőfelületét 8 másodpercig, amíg a fülhallgatók LED jelzői háromszor gyorsan pirosan villognak.



## LED FÉNY ÚTMUTATÓ

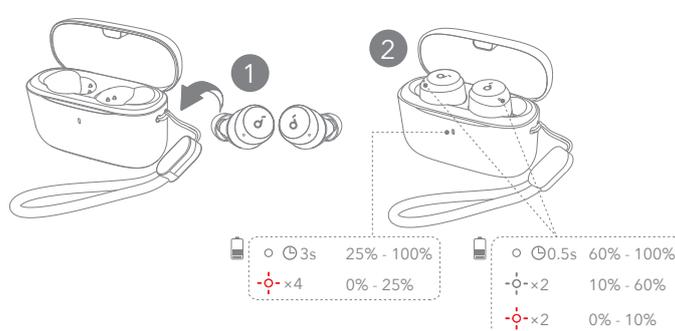

- Folyamatos fehér
- Villogó fehér
- Villogó vörös

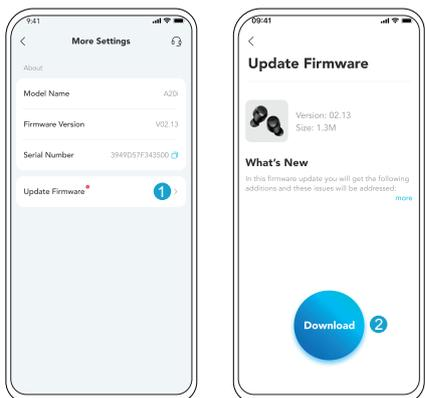

Amikor csatlakoztatja a fülhallgatót az alkalmazáshoz, értesítést fog kapni az új firmware verzió észlelésekor. Győződjön meg arról, hogy a fülhallgatók a töltőtokban vannak, és a tok nyitva marad, amíg a firmware frissítés be nem fejeződik. Az frissítés során győződjön meg róla, hogy a fülhallgatók töltődnek, és kerülje a használatukat.

A specifikációkat előzetes értesítés nélkül módosíthatjuk.

Bemenet	5 V --- 0,5A
Névleges kimeneti teljesítmény	5 mW
Akkukapacitás	60 mAh × 2 (fülhallgató); 350 Ah (töltőtök)
Töltési idő	Akár 2 óra
Lejátszási idő (a hangerő és a tartalom függvényében)	Akár 9 óra (akár 28 óra a töltőtökkel együtt)
Hangszóró	6 mm dinamikus hangszóró
Frekvenciaátvitel	20 Hz-20 kHz
Impendencia	16Ω
Vízállóság szintje (fülhallgató)	IPX5
Bluetooth-verzió	5.3
Bluetooth-tartomány	10 m



## APP



Google Play and the Google Play logo are trademarks of Google Inc.



Apple and the Apple logo are trademarks of Apple Inc.



## USO

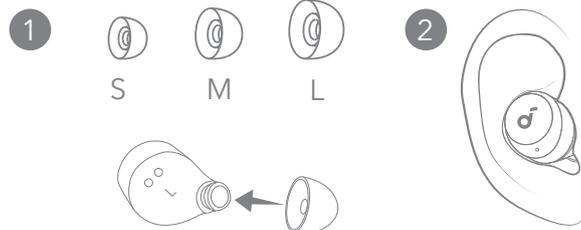

Scarica l'app soundcore per migliorare la tua esperienza (modalità di gioco, trova dispositivo, equalizzazione, aggiornamento firmware e altro ancora).

Se gli auricolari non riescono a connettersi con l'app soundcore, aggiornali all'ultima versione nell'app store del proprio dispositivo mobile.

Scegliere i copriauricolari più adatti alle proprie orecchie.



## CARICAMENTO

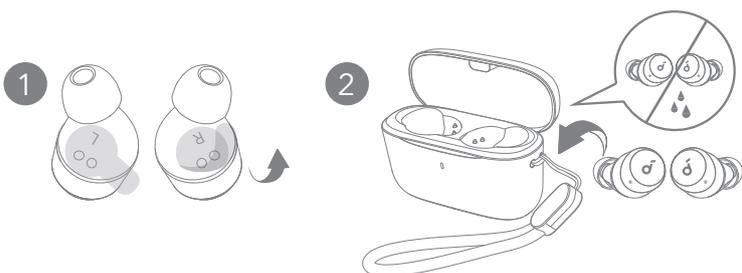

1. Togli l'adesivo di isolamento sugli auricolari prima del primo utilizzo.
2. Riponi gli auricolari nella custodia di ricarica e chiudila.
  - Asciugare completamente gli auricolari e la porta di ricarica USB-C prima del caricamento.

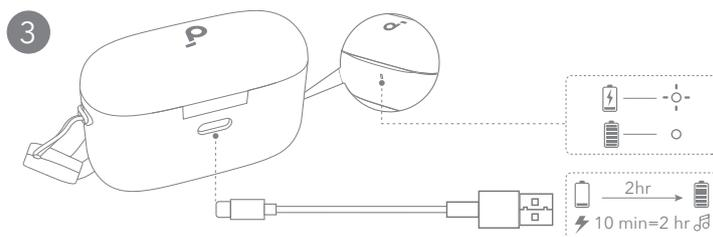

3. Collegare la custodia di ricarica a una fonte di alimentazione utilizzando un cavo di ricarica USB-C certificato.
  - Caricare completamente sia gli auricolari che la custodia di ricarica prima del primo utilizzo.

## ACCENSIONE E ABBINAMENTO

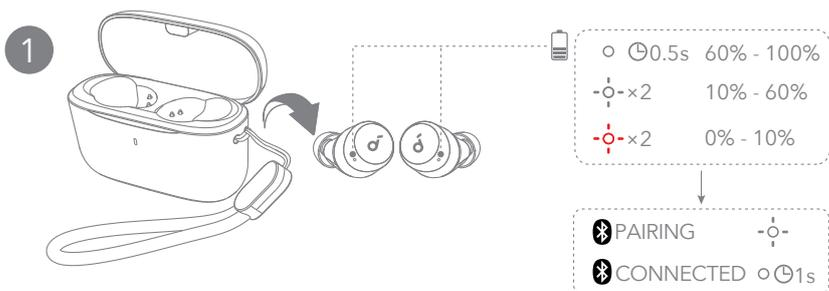

Apri la custodia di ricarica e prendi gli auricolari. Queste si accenderanno automaticamente ed entreranno in modalità di abbinamento Bluetooth.

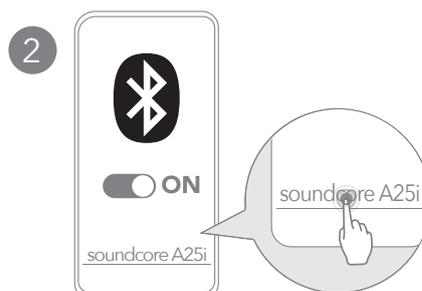

Seleziona **"soundcore A20i/A25i"** \* dalla lista Bluetooth del tuo dispositivo quando ti connetti per la prima volta.

\*Il nome del dispositivo può variare a seconda della regione.



## ABBINAMENTO MANUALE

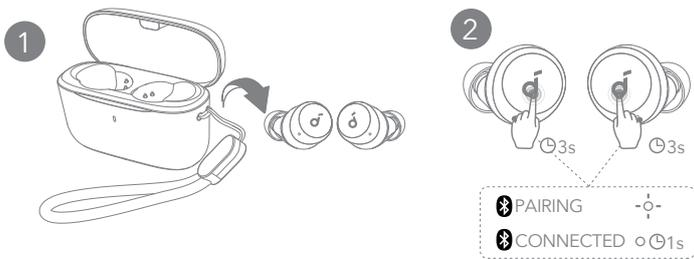

Per entrare manualmente in modalità di abbinamento Bluetooth, togliere gli auricolari dall'astuccio, quindi tenere premuti i touchpad su entrambi gli auricolari per 3 secondi fino a quando gli indicatori LED degli auricolari lampeggiano rapidamente di colore bianco.



## CONTROLLI

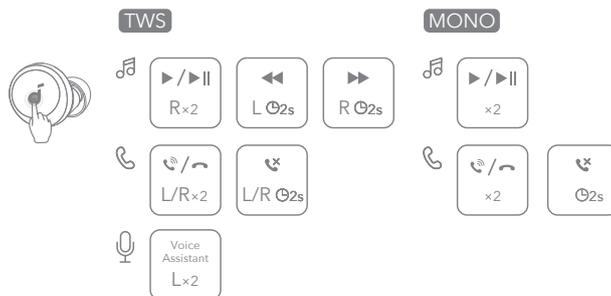

È possibile anche personalizzare i controlli nell'app soundcore.



## CONTROLLI

	Modalità TWS	Modalità mono
	Riproduzione/Pausa Toccare due volte (D)	Toccare due volte
	Brano precedente Tenere premuto per 2 secondi (S)	/
	Brano successivo Tenere premuto per 2 secondi (D)	/
	Rispondere/Terminare una chiamata Toccare due volte (S/D)	Toccare due volte
	Rifiuta chiamata Tenere premuto per 2 secondi (S/D)	Tieni premuto per 2 secondi
	Attiva il software dell'assistente vocale Toccare due volte (S)	/



## SPEGNIMENTO

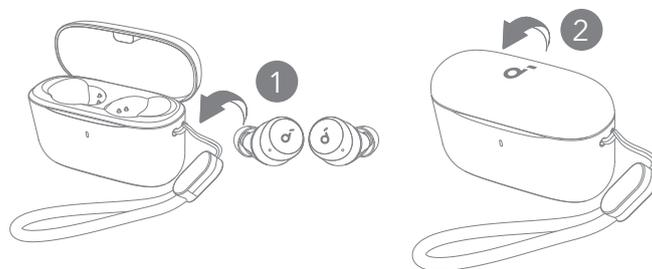

Per spegnere, inserire di nuovo gli auricolari nella custodia di ricarica e chiuderla. Gli auricolari si spegneranno automaticamente dopo 30 minuti se non sono collegati.



## RESET

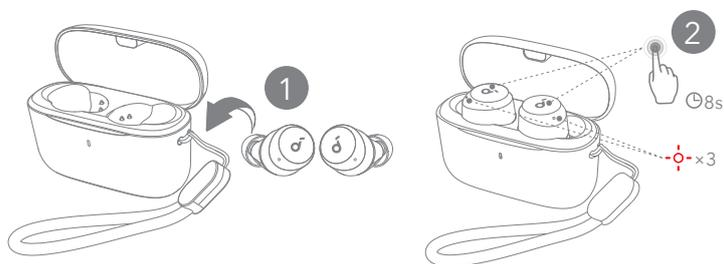

Procedi a un ripristino se gli auricolari hanno problemi ad associarsi tra loro o con altri dispositivi. Sistemare gli auricolari nella custodia di ricarica e lasciare la custodia aperta, quindi toccare e tenere premuti i touchpad su entrambi gli auricolari per 8 secondi fino a quando gli indicatori LED degli auricolari lampeggiano rapidamente tre volte di colore rosso.



## GUIDA LUCE LED

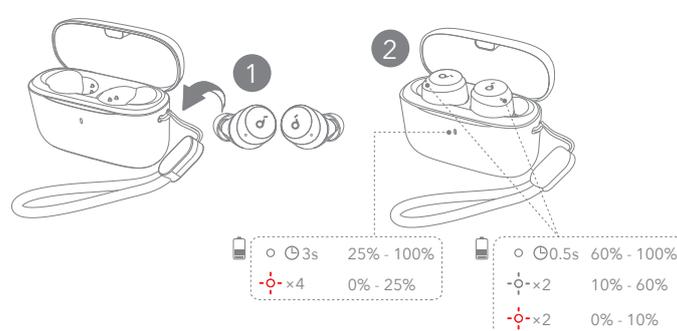

- Bianco fisso
- Bianco lampeggiante
- Rosso lampeggiante



## AGGIORNAMENTO DEL FIRMWARE

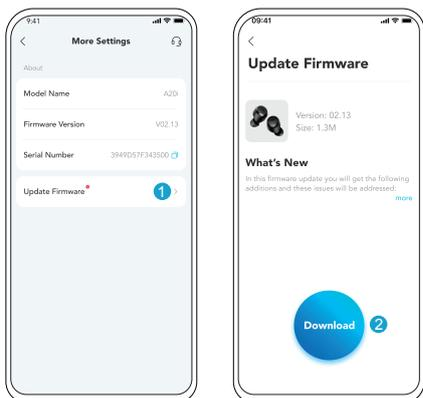

Riceverai una notifica non appena viene rilevata una nuova versione del firmware quando colleghi gli auricolari all'app. Assicurati che gli auricolari siano stati sistemati nella custodia di ricarica e che la custodia rimanga aperta fino al termine dell'aggiornamento del firmware. Durante l'aggiornamento, assicurati che gli auricolari siano in carica ed evita di utilizzarli.



## SPECIFICHE

Le specifiche sono soggette a modifiche senza preavviso.

Ingresso	5V $\overline{\text{---}}$ 0,5A
Potenza di uscita nominale	5 mW
Capacità della batteria	60 mAh $\times$ 2 (auricolari); 350 Ah (custodia di ricarica)
Durata della ricarica	Fino a 2 ore
Tempo di riproduzione (varia a seconda del livello di volume e del contenuto)	Fino a 9 ore (fino a 28 ore con la custodia di ricarica)
Unità driver	Driver dinamico da 6 mm.
Risposta in frequenza	20 Hz - 20 kHz
Impedenza	16 $\Omega$
Livello impermeabilità (auricolari)	IPX5
Versione Bluetooth	5.3
Portata Bluetooth	10 m



## APP



Google Play and the Google Play logo are trademarks of Google Inc.



Apple and the Apple logo are trademarks of Apple Inc.



Download de soundcore-app om uw ervaring te verbeteren (Gaming-modus, Apparaat zoeken, EQ-tuning, Firmware-update en meer). Als uw oordopjes geen verbinding met de soundcore-app kunnen maken, moet u de app bijwerken naar de nieuwste versie in de appwinkel.



## DRAGEN

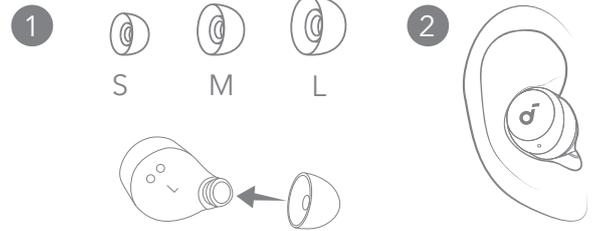

Kies de oorkussentjes die het beste bij uw oren passen.



## OPLADEN

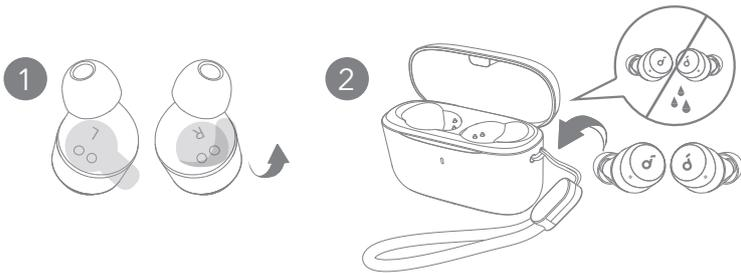

1. Trek voor het eerste gebruik de isolatiesticker van de oordopjes.
  2. Plaats de oordopjes in het oplaaddoosje en sluit het doosje.
- Droog de oordopjes en de USB-C-oplaadpoort vóór het opladen volledig af.

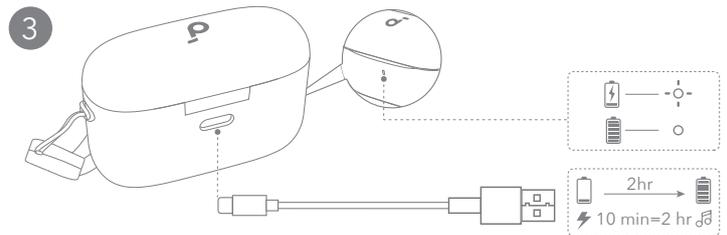

3. Sluit de oplaadcase aan op een voeding met behulp van een gecertificeerde USB-C oplaadkabel.
- Laad zowel de oordopjes als de oplaadcase volledig op voor het eerste gebruik.



## INSCHAKELEN EN KOPPELEN

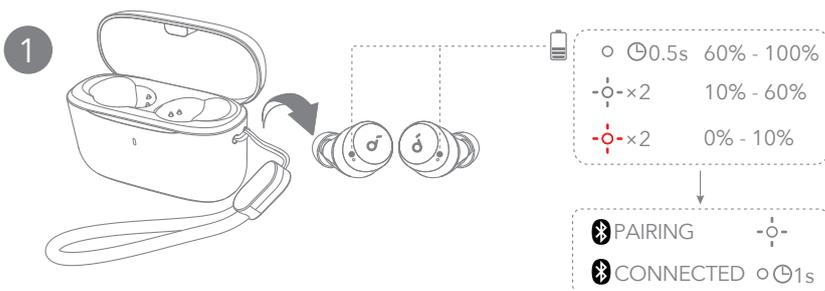

Open de oplaadcase en haal de oordopjes eruit. De bril start op en de bluetoothkoppelstand wordt gestart.

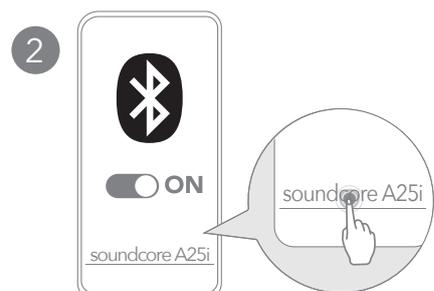

Selecteer **"soundcore A20i / A25i"** \* in de Bluetooth-lijst van uw apparaat wanneer u voor het eerst verbinding maakt.

\*De naam van het apparaat is afhankelijk van de regio.



## HANDMATIG KOPPELEN

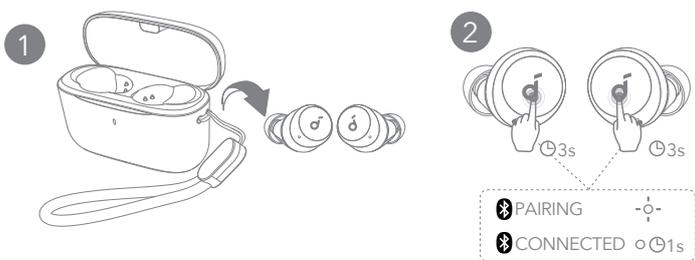

Om de Bluetooth-koppelingsmodus handmatig in te schakelen, neemt u de oordopjes uit de case en houdt u de touchpads op beide oordopjes 3 seconden lang ingedrukt totdat de LED-indicatoren van de oordopjes snel wit knipperen.



## BEDIENING

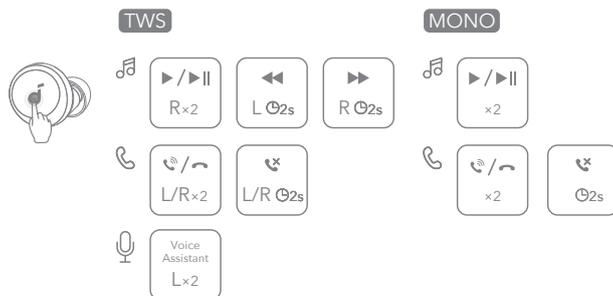

U kunt de bediening in de soundcore-app aanpassen.



## BEDIENING

	TWS-modus	Monomodus
Afspelen / pauzeren	Tik twee keer (R)	Tik twee keer
Vorig nummer	Twee seconden ingedrukt houden (L)	/
Volgend nummer	Twee seconden ingedrukt houden (R)	/
Oproep beantwoorden / beëindigen	Tik twee keer (L/R)	Tik twee keer
Oproep weigeren	Houd 2 seconden aangetikt (L/R)	Twee seconden ingedrukt houden
Spraakbesturingssoftware activeren	Tik twee keer (L)	/



## UITSCHAKELEN

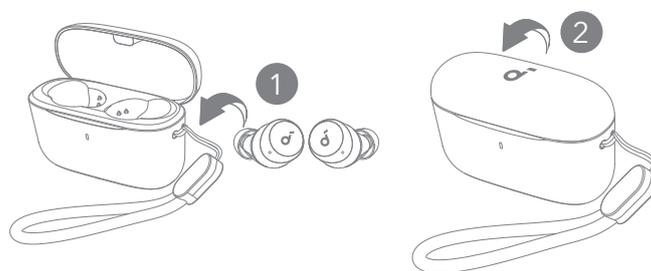

Om de oordopjes uit te schakelen, doet u ze terug in het oplaaddoosje en sluit u het doosje. De oordopjes worden na 30 minuten automatisch uitgeschakeld als ze niet zijn aangesloten.



## RESETTEN

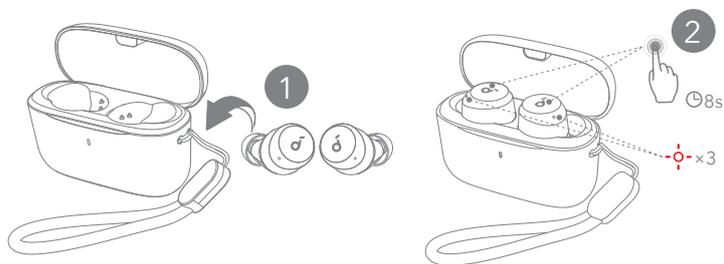

Als de oordopjes niet goed met elkaar of met andere apparaten kunnen worden gekoppeld, moet u ze resetten. Plaats de oordopjes in de oplaadcase en laat de case open, tik vervolgens op de touchpads van beide oordopjes en houd deze 8 seconden ingedrukt totdat de LED-indicatoren van de oordopjes drie keer snel rood knipperen.



## STATUSAANDUIDING INDICATIELED

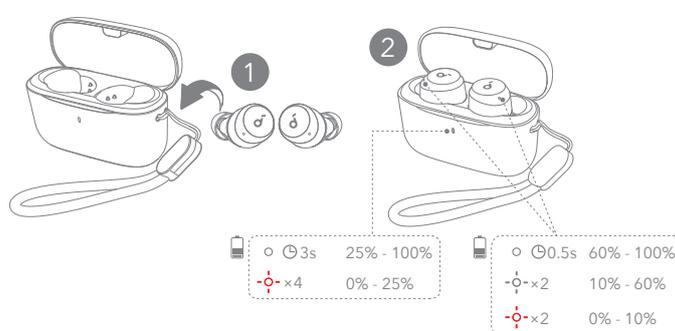

- Brandt wit
- Knippert wit
- Knippert rood



## FIRMWARE-UPDATE

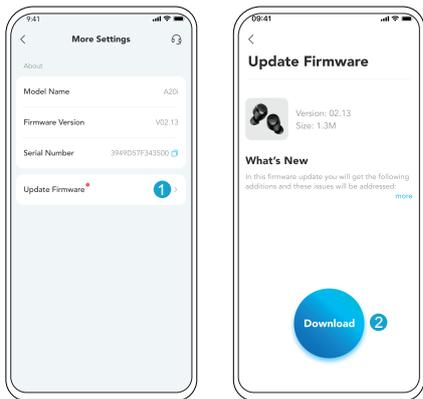

U krijgt een melding zodra er een nieuwe firmwareversie is gedetecteerd wanneer u de oordopjes aansluit op de app. Zorg ervoor dat de oordopjes in het oplaadoosje zijn geplaatst en het hoesje open blijft totdat de firmware-update is voltooid. Zorg er tijdens de update voor dat de oordopjes worden opgeladen en vermijd elk gebruik.



## SPECIFICATIES

Specificaties zijn onderhevig aan verandering zonder kennisgeving.

Ingang	5V $\overline{\text{---}}$ 0.5A
Nominaal uitgangsvermogen	5 mW
Batterijcapaciteit	2 × 60 mAh (oordopjes); 350Ah (laadcase)
Oplaadtijd	Maximaal 2 uur
Afspeeltijd (afhankelijk van volume en materiaal dat wordt afgespeeld)	Tot 9 uur (tot 28 uur met de oplaadcase)
Driver	6mm dynamische driver
Frequentierespons	20 Hz - 20 kHz
Impedantie	16 $\Omega$
Waterdichtheid (oordopjes)	IPX5
Bluetooth-versie	5.3
Bluetooth-bereik	10 m



## APP



Google Play and the Google Play logo are trademarks of Google Inc.



Apple and the Apple logo are trademarks of Apple Inc.



Last ned Soundcore-appen for å forbedre opplevelsen din (spillmodus, finn enhet, EQ-justering, fast programvare-oppdatering og mer).

Hvis øreproppene dine ikke kan kobles til soundcore-appen, oppdaterer du den til den nyeste versjonen i mobilappbutikken din.



## BRUK

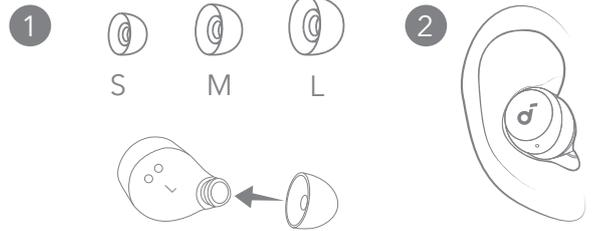

Velg tuppene som passer best til ørene dine.



## OPLADEN

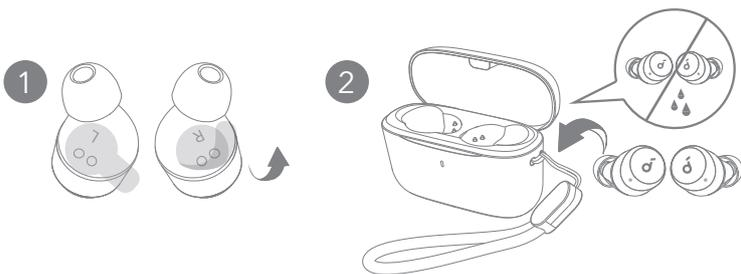

1. Fjern klistremerket på øreproppene før første gangs bruk.
  2. Legg ørepluggene i ladeetuiet og lukk det.
- Tørk godt av øreproppene og USB-C-ladeporten før lading.

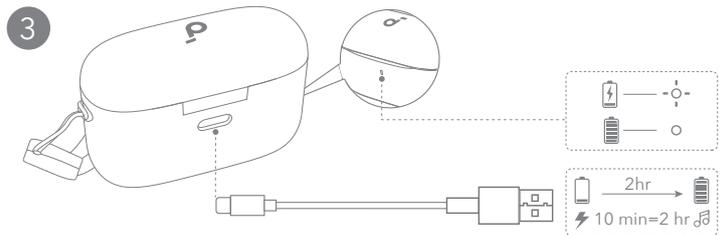

3. Koble ladeetuiet til strømforsyningen ved å bruke en godkjent USB-C-ladekabel.
- Lad begge øreproppene og ladeetuiet fullt opp før første gangs bruk.



## INSCHAKELEN EN KOPPELEN

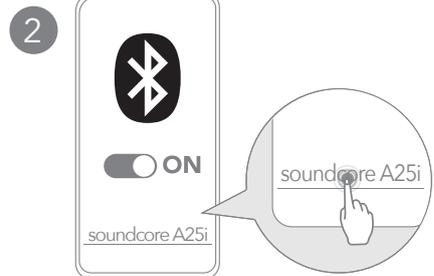
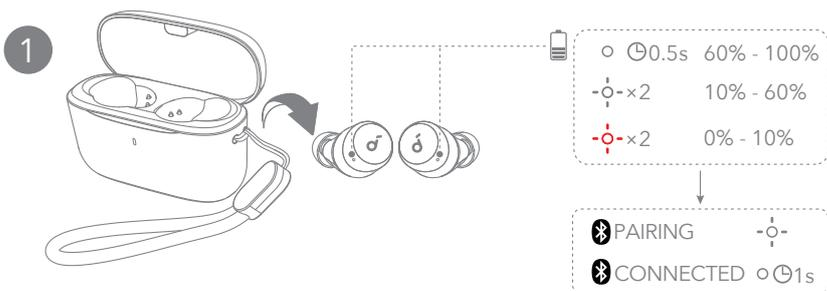

Åpne ladeetuiet og ta ut øreproppene. Soundcore Frames slår seg automatisk på og går inn i Bluetooth-paringsmodus.

Velg «**soundcore A20i/A25i**» \* på Bluetooth-listen på enheten din når du kobler til for første gang.

\*Enhetsnavnet kan variere avhengig av regionen.



# HANDMATIG KOPPELEN

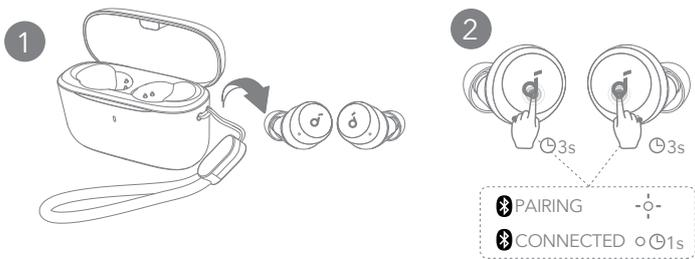

For å manuelt aktivere Bluetooth-parring, ta øreproppene ut av saken, trykk og hold på berøringsflatene på begge øreproppene i 3 sekunder til øreproppenes LED-indikatorer blinker raskt hvitt.



# KONTROLLER

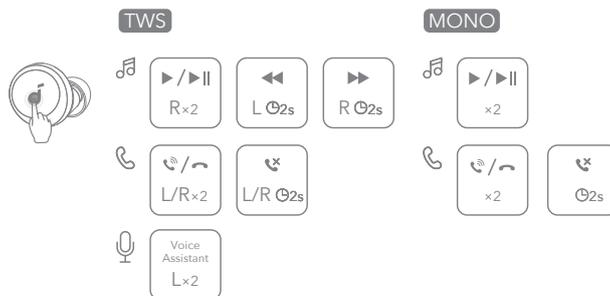

Du kan tilpasse kontrollene i soundcore-appen.



# KONTROLLER

	TWS-modus	Monomodus
Spill av / pause	Bank to ganger (H)	Trykk to ganger
Forrige spor	Trykk og hold inne i 2 sekunder (V)	/
Neste spor	Trykk og hold inne i 2 sekunder (H)	/
Besvar/avslutt et anrop	Bank to ganger (H/V)	Trykk to ganger
Avvis et anrop	Trykk på og hold i 2 sekunder (H/V)	Trykk og hold inne i 2 sekunder
Aktiver taleassistentprogramvaren	Bank to ganger (V)	/



# UITSCHAKELEN

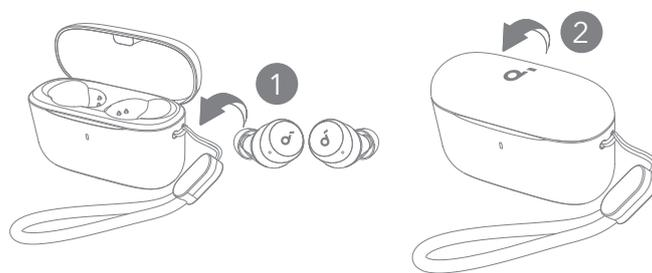

For å slå av, legger du øreproppene tilbake i ladeetuiet og lukker det. Øreproppene vil automatisk slå seg av etter 30 minutter hvis de ikke er tilkoblet.



# RESETTEN

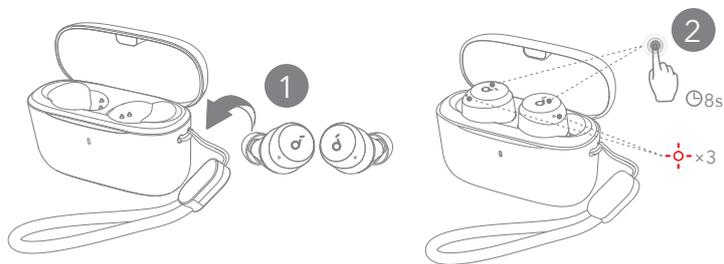

Tilbakestill hvis øreproppene har problemer med å pares med hverandre eller med andre enheter. Legg øreproppene i ladeetuiet og la etuiet være åpent, deretter trykk og hold touchpadene på begge øreproppene i 8 sekunder til øreproppenes LED-indikatorer blinker raskt rødt tre ganger.



# LED-LYSVEILEDNING

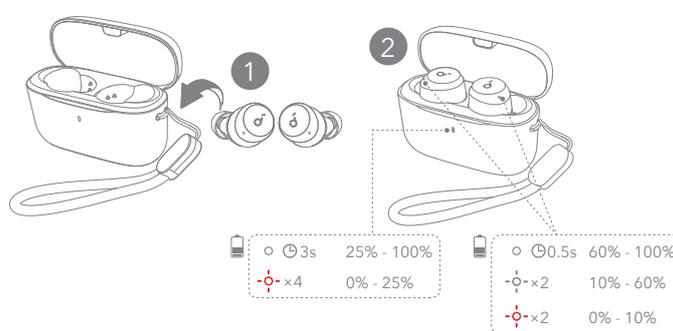

- Lyser kontinuerlig hvitt
- Blinker hvitt
- Blinker rødt

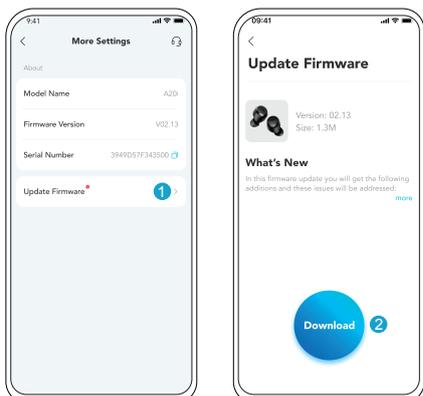

Du vil bli varslet når en ny fast programvare-versjon blir oppdaget når du kobler øreproppene til appen. Sørg for at øreproppene er plassert i ladeetuiet og at etuiet forblir åpent til fast programvare-oppdateringen er fullført. Under oppdateringen, sørg for at øreproppene lades og unngå all bruk.

Spesifikasjoner kan endres uten varsel.

Inngangsspenning	5V $\overline{\text{---}}$ 0.5A
Nominell utgangseffekt	5 mW
Batterikapasitet	60 mAh $\times$ 2 (ørepropper); 350Ah (ladeetui)
Ladetid	Opptil 2 timer
Avspillingstid (varierer etter volumnivå og innhold)	Opptil 9 timer (opptil 28 timer med ladeetuiet)
Driverenhet	6mm dynamisk driver
Frekvensrespons	20 Hz - 20 kHz
Impedans	16 $\Omega$
Vannrett nivå (øreplugg)	IPX5
Bluetooth-versjon	5.3
Bluetooth-dekningsområde	10 m



## APLIKACJA



Google Play and the Google Play logo are trademarks of Google Inc.



Apple and the Apple logo are trademarks of Apple Inc.



Pobierz aplikację Soundcore, aby ulepszyć swoje doświadczenie (tryb gry, znajdź urządzenie, dostosowanie EQ, aktualizacja oprogramowania itd.).

Jeżeli wystąpią problemy z połączeniem słuchawek i aplikacji soundcore, zaktualizuj ją do najnowszej wersji, przechodząc do sklepu z aplikacjami mobilnymi.



## UŻYTKOWANIE

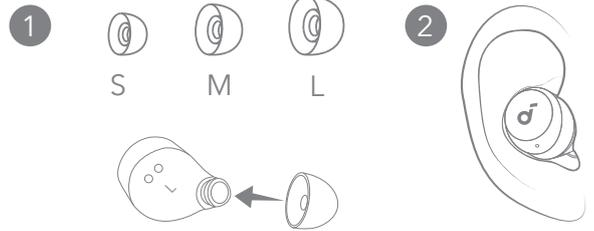

Wybierz końcówki douszne najlepiej pasujące do Twoich uszu.



## ŁADOWANIE

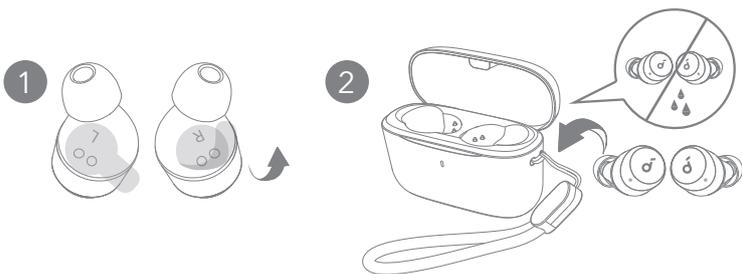

1. Przed pierwszym użyciem usuń naklejkę izolacyjną z wkładek dousznych.
2. Umieść słuchawki douszne w etui ładującym i je zamknij.
  - Przed ładowaniem dokładnie wyczyść słuchawki douszne i port ładowania USB-C.

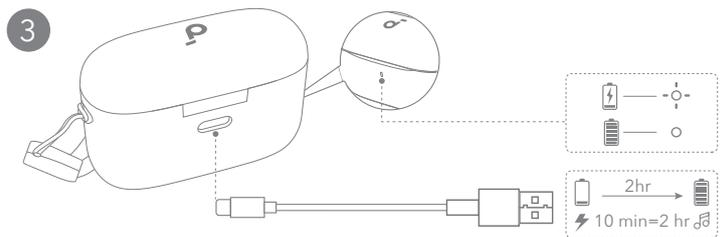

3. Podłącz etui do ładowania do źródła zasilania za pomocą certyfikowanego kabla ładowania USB-C.
  - W pełni naładuj zarówno słuchawki, jak i etui do ładowania przed pierwszym użyciem.



## WŁĄCZANIE I PAROWANIE

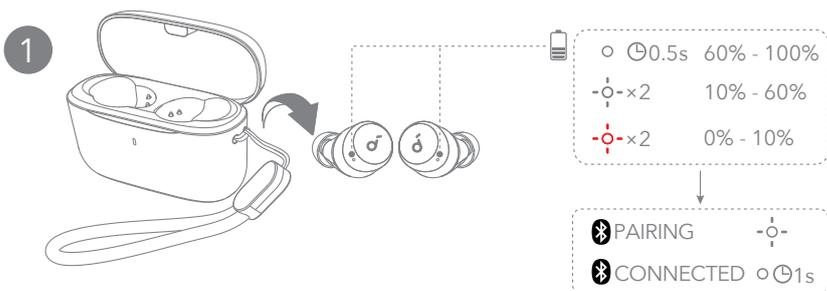

Otwórz etui do ładowania i wyjmij słuchawki douszne. Włączy się automatycznie w trybie parowania Bluetooth.

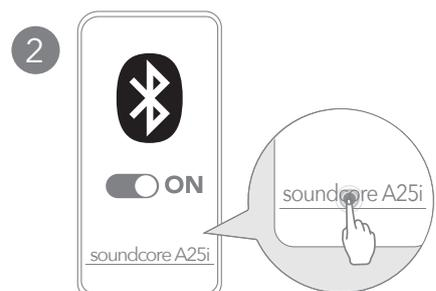

Wybierz **"soundcore A20i / A25i"** \* na liście Bluetooth urządzenia podczas pierwszego podłączenia.

\* Nazwa urządzenia może się różnić w zależności od regionu.



## PAROWANIE RĘCZNE

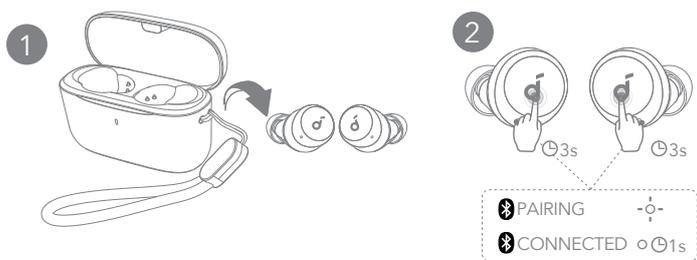

Aby ręcznie wejść w tryb parowania Bluetooth, wyjmij słuchawki z etui, następnie dotknij i przytrzymaj touchpady na obu słuchawkach przez 3 sekundy, aż wskaźniki LED słuchawek zaczną szybko migać na biało.



## STEROWANIE

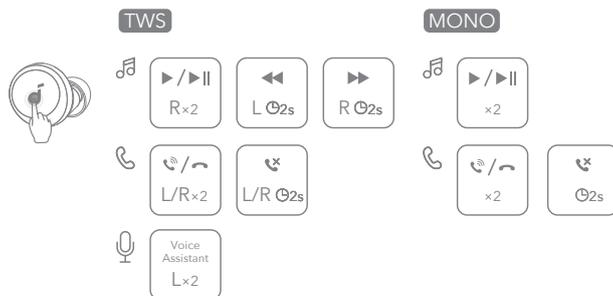

Elementy sterujące możesz również dostosować w aplikacji Soundcore.



## STEROWANIE

	Tyb TWS	Tryb mono
	Odtwarzanie/ wstrzymanie	Dwukrotne stuknięcie (P)
	Poprzedni utwór	Dotknij i przytrzymaj przez 2 sekundy (L)
	Następny utwór	Dotknij i przytrzymaj przez 2 sekundy (P)
	Odbieranie/ zakończanie połączenia	Dwukrotne stuknięcie (L/P)
	Odrzucenie połączenia	Nacisnąć i przytrzymać przez 2 sekundy (L/P)
	Aktywuj oprogramowanie asystenta głosowego	Dwukrotne stuknięcie (L)



## WYŁĄCZANIE

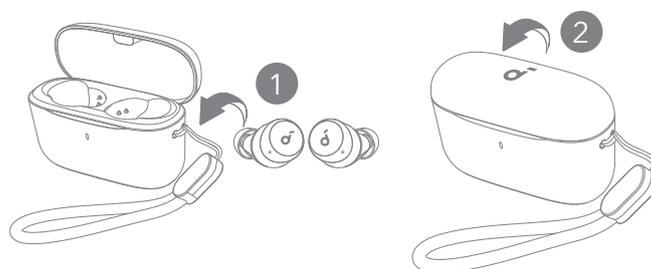

W celu wyłączenia zasilania umieść ponownie słuchawki w etui ładującym i zamknij je. Słuchawki douszne automatycznie wyłączą się po 30 minutach, jeśli nie będą połączone.



## RESET

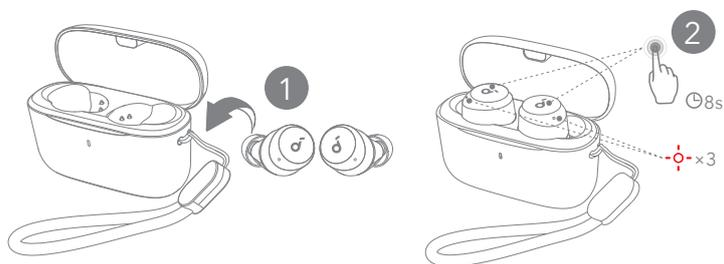

Jeśli słuchawki nie mogą prawidłowo sparować się ze sobą lub z innymi urządzeniami, zresetuj je. Umieść słuchawki w etui do ładowania i pozostaw etui otwarte, następnie dotknij i przytrzymaj touchpad na obu słuchawkach przez 8 sekund, aż wskaźniki LED słuchawek zamigają trzy razy szybko na czerwono.



## PRZEWODNIK PO DIODACH LED

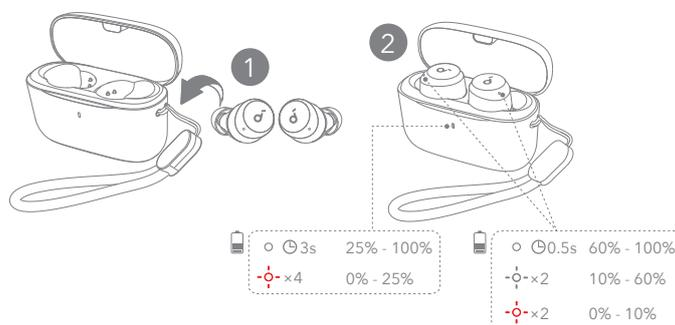

- Światło ciągłe białe
- Migające światło białe
- Migająca czerwona dioda

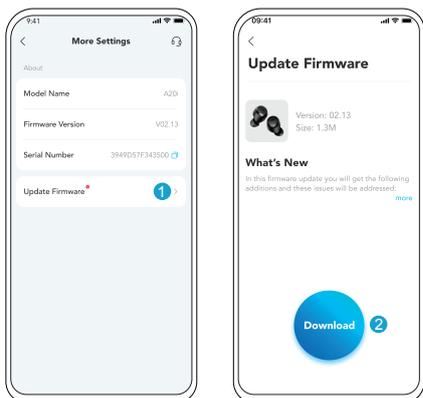

Podłączając słuchawki do aplikacji, zostaniesz powiadomiony(-a), gdy zostanie wykryta nowa wersja oprogramowania. Upewnij się, że słuchawki są umieszczone w etui do ładowania, a etui pozostaje otwarte do momentu zakończenia aktualizacji oprogramowania. Podczas aktualizacji upewnij się, że słuchawki są ładowane i unikaj ich użytkowania.

Dane techniczne mogą ulec zmianie bez powiadomienia.

Wejście	5 V --- 0,5 A
Znamionowa moc wyjściowa	5 mW
Pojemność akumulatora	60 mAh × 2 (wkładki douszne); 350 Ah (etui ładowania)
Czas ładowania	Do 2 godz.
Czas odtwarzania (różni się zależnie od głośności i zawartości)	Do 9 godzin (do 28 godzin z etui ładowania)
Moduł sterujący	6-milimetrowy dynamiczny przetwornik
Charakterystyka częstotliwościowa	20 Hz - 20 kHz
Impedancja	16Ω
Poziom wodoodporności (słuchawki douszne)	IPX5
Wersja Bluetooth	5.3
Zasięg Bluetooth	10 m / 33 st.



## APLICAÇÃO



Google Play and the Google Play logo are trademarks of Google Inc.



Apple and the Apple logo are trademarks of Apple Inc.



Baixe o aplicativo soundcore para aprimorar sua experiência (modo de jogo, encontrar dispositivo, ajuste de EQ, atualização de firmware e mais).

Se os seus auriculares não conseguirem ligar-se à aplicação soundcore, atualize-a para a versão mais recente na loja de aplicações móveis.



## UTILIZAÇÃO

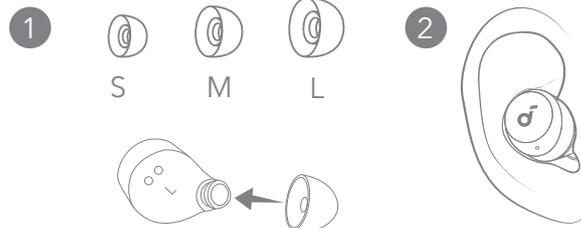

Escolha as borrachas que melhor se adaptam a si.



## CARREGAMENTO

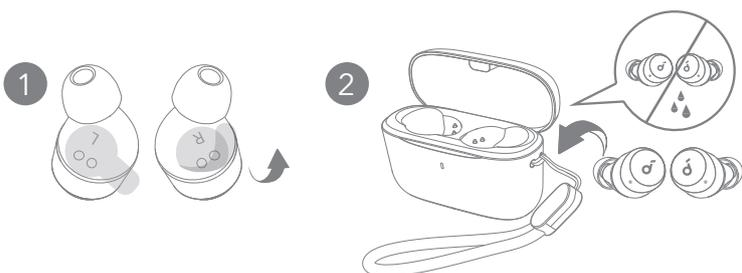

1. Retire o autocolante de isolamento nos auriculares antes da primeira utilização.
2. Coloque os auriculares na caixa de carregamento e feche-a.
  - Seque totalmente os auriculares e a porta de carregamento USB-C antes do carregamento.

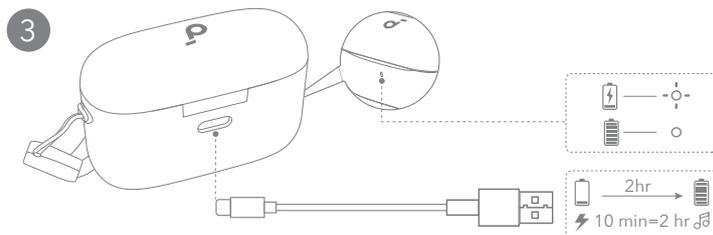

3. Conecte o estojo de carregamento a uma fonte de energia usando um cabo de carregamento USB-C certificado.
  - Carregue completamente tanto os fones de ouvido quanto o estojo de carregamento antes do primeiro uso.



## LIGAR E EMPARELHAR

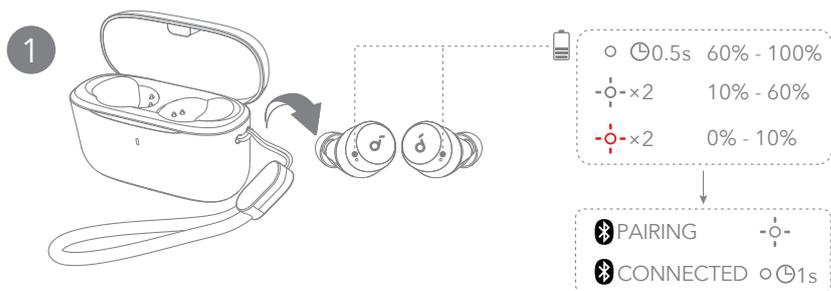

Abra o estojo de carregamento e retire os fones de ouvido. Ligam-se automaticamente e ativam o modo de emparelhamento por Bluetooth.

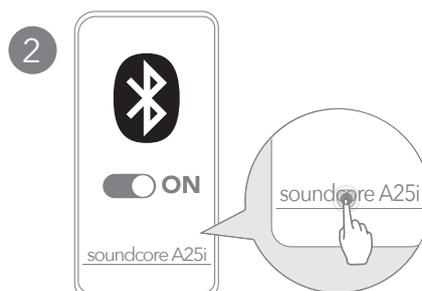

Selecione **"soundcore A20i / A25i"** \* na lista de Bluetooth do seu dispositivo ao conectar pela primeira vez.

\*O nome do dispositivo pode variar consoante a região.



# EMPARELHAMENTO MANUAL

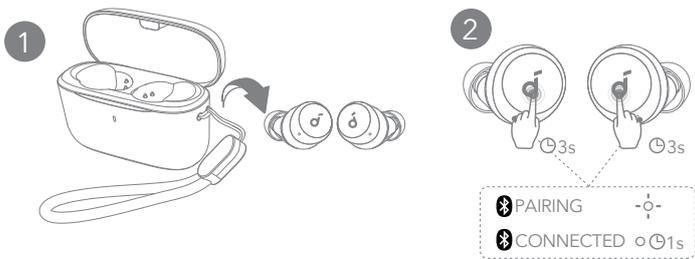

Para entrar manualmente no modo de emparelhamento Bluetooth, retire os fones de ouvido da caixa, em seguida, toque e segure os touchpads em ambos os fones de ouvido por 3 segundos até que os indicadores LED dos fones de ouvido pisquem rapidamente em branco.



# CONTROLOS



Também pode personalizar os controlos na aplicação soundcore.



# CONTROLOS

	Modo TWS	Modo mono
Reproduzir/Pausar	Tocar duas vezes (D)	Tocar duas vezes
Faixa anterior	Toque sem soltar durante 2 segundos (E)	/
Próxima faixa	Toque sem soltar durante 2 segundos (D)	/
Atender/terminar uma chamada	Tocar duas vezes (E/D)	Tocar duas vezes
Rejeitar uma chamada	Tocar continuamente durante 2 segundos (E/D)	toque sem soltar durante 2 segundos
Ativar o software de assistente por voz	Tocar duas vezes (E)	/



# DESLIGAR

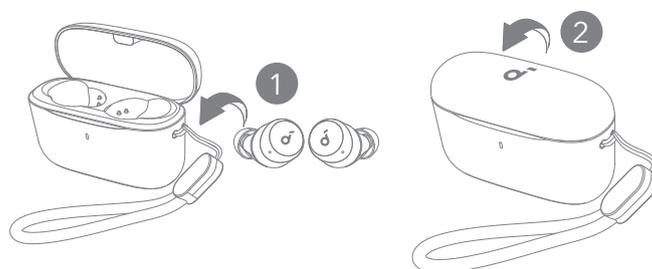

Para desligar os auriculares, coloque-os na caixa de carregamento e feche-a. Os fones de ouvido sem fio desligarão automaticamente após 30 minutos se não estiverem conectados.



# REPOR

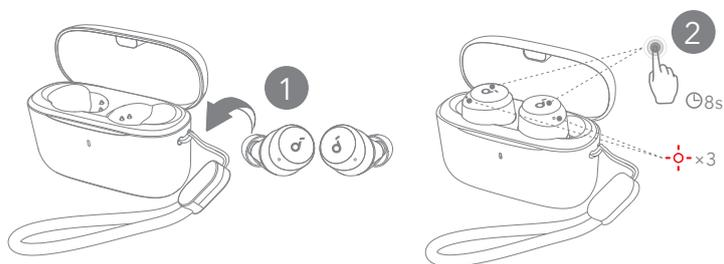

Efetue a reposição caso surjam problemas de emparelhamento entre os auriculares ou com outros dispositivos. Coloque os fones de ouvido no estojo de carregamento e deixe o estojo aberto, em seguida, toque e segure os touchpads em ambos os fones de ouvido por 8 segundos até que os indicadores LED dos fones de ouvido pisquem rapidamente em vermelho três vezes.



# GUIA DE LUZ LED

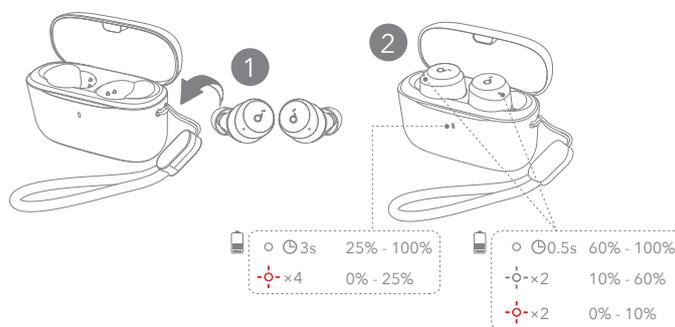

- Branco fixo
- Branco intermitente
- Vermelho intermitente



## ATUALIZAÇÃO DO FIRMWARE

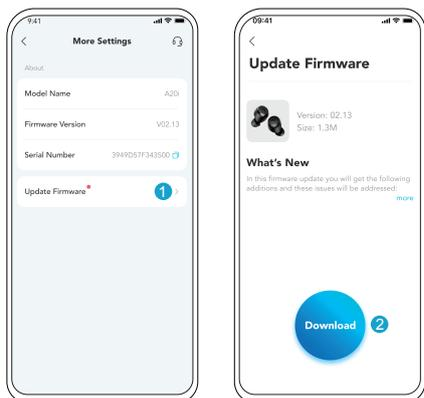

Você será notificado assim que uma nova versão de firmware for detectada quando você conectar os fones de ouvido ao aplicativo. Certifique-se de que os fones de ouvido estejam colocados no estojo de carregamento e que o estojo permaneça aberto até que a atualização do firmware esteja completa. Durante a atualização, certifique-se de que os fones de ouvido estão sendo carregados e evite qualquer uso.



## ESPECIFICAÇÕES

As especificações estão sujeitas a alteração sem aviso prévio.

Entrada	5V $\overline{\text{---}}$ 0.5A
Potência de saída nominal	5 mW
Capacidade da bateria	60 mAh $\times$ 2 (auriculares); 350Ah (estojo de carregamento)
Tempo de carregamento	Até 2 horas
Tempo de reprodução (Varia consoante o nível do volume e o conteúdo)	Até 9 horas (até 28 horas com a caixa de carregamento)
Unidade de diafragma	Driver dinâmico de 6mm
Resposta de frequência	20 Hz - 20 kHz
Impedância	16 $\Omega$
Nível de resistência à água (auriculares)	IPX5
Versão do Bluetooth	5.3
Alcance do Bluetooth	10 m



## APLICATIVO



Google Play and the Google Play logo are trademarks of Google Inc.



Apple and the Apple logo are trademarks of Apple Inc.



## COMO USAR

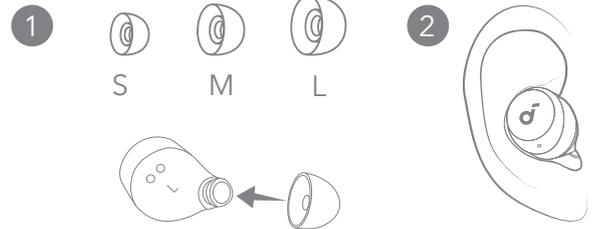

Escolha os Ear Tips mais adequados para seu ouvido.

Baixe o aplicativo Soundcore para aprimorar sua experiência (modo de jogo, encontre dispositivo, ajuste de EQ, atualização de firmware e muito mais).

Se seus fones de ouvido não puderem se conectar ao aplicativo soundcore, atualize-o para a versão mais recente em sua loja de aplicativos para dispositivos móveis.

## CARREGANDO A BATERIA

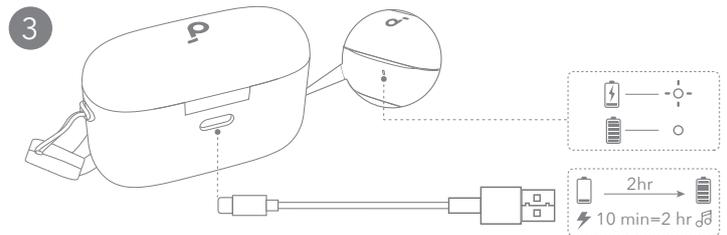
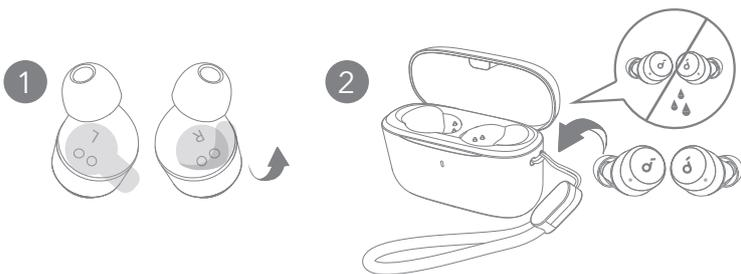

1. Remova o adesivo de isolamento dos fones de ouvido antes do primeiro uso.
2. Coloque os fones de ouvido no estojo carregador e feche-o.
  - Seque totalmente os fones de ouvido e a porta de carregamento USB-C antes de carregar.

3. Conecte o estojo de carregamento a uma fonte de energia usando um cabo de carregamento USB-C certificado.
  - Carregue completamente tanto os fones de ouvido quanto o estojo de carregamento antes do primeiro uso.

## LIGANDO E PAREANDO

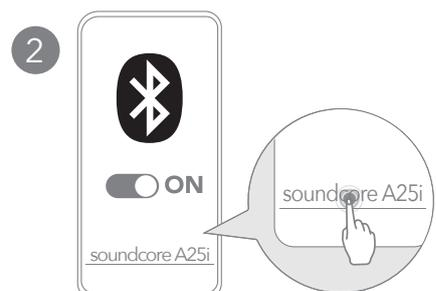
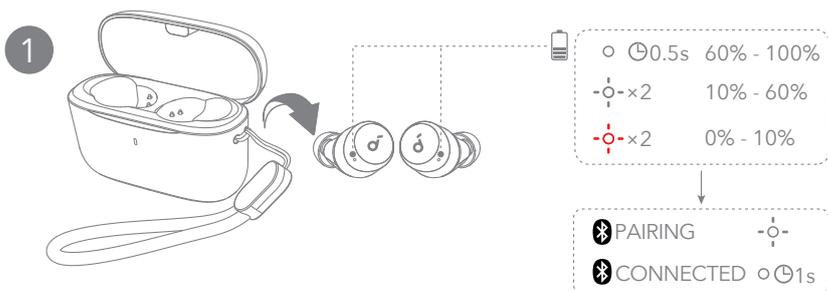

Abra o estojo de carregamento e retire os fones de ouvido. Elas ligarão e entrarão no modo de pareamento Bluetooth automaticamente.

Selecione "**soundcore A20i / A25i**" \* na lista de Bluetooth do seu dispositivo ao conectar pela primeira vez.

\*O nome do dispositivo pode variar dependendo da região.



# PAREAMENTO MANUAL

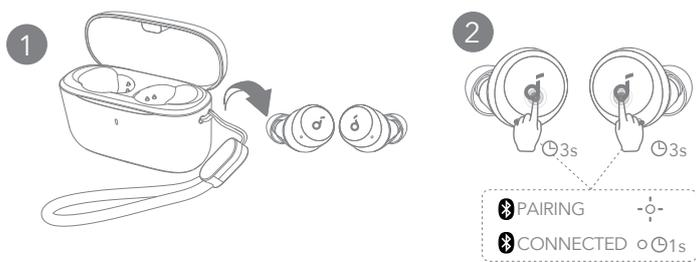

Para entrar manualmente no modo de emparelhamento Bluetooth, retire os fones de ouvido do estojo e, em seguida, toque e segure os touchpads em ambos os fones de ouvido por 3 segundos até que os indicadores LED dos fones de ouvido pisquem rapidamente em branco.



# CONTROLES



Você também pode personalizar os controles no aplicativo soundcore.



# CONTROLES

	Modo TWS	Modo mono
Reproduzir/Pausar	Toque duas vezes (D)	Toque duas vezes
Faixa anterior	Toque e mantenha pressionado por 2 segundos (L)	/
Próxima faixa	Toque e mantenha pressionado por 2 segundos (R)	/
Atender/Encerrar uma chamada	Toque duas vezes (E/D)	Toque duas vezes
Rejeitar chamada	Mantenha pressionado por cerca de 2 segundo (E/D)	Toque e mantenha pressionado por 2 segundos
Ative o software do assistente de voz	Toque duas vezes (E)	/



# DESLIGANDO

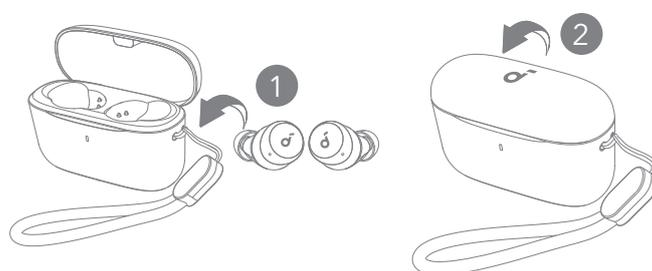

Para desligar, coloque os fones de ouvido de volta no estojo carregador e feche-o. Os fones de ouvido serão desligados automaticamente após 30 minutos se não estiverem conectados.



# REINICIAR

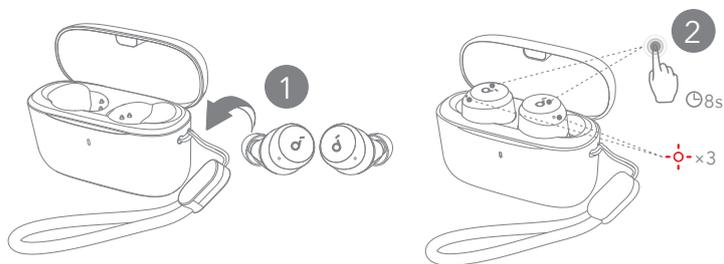

Reinicie se os fones de ouvido não puderem ser emparelhados corretamente entre si ou com outros dispositivos. Coloque os fones de ouvido no estojo de carregamento e deixe o estojo aberto, em seguida, toque e segure os touchpads em ambos os fones de ouvido por 8 segundos até que os indicadores LED dos fones de ouvido pisquem rapidamente em vermelho por três vezes.



# GUIA DA LUZ DE LED

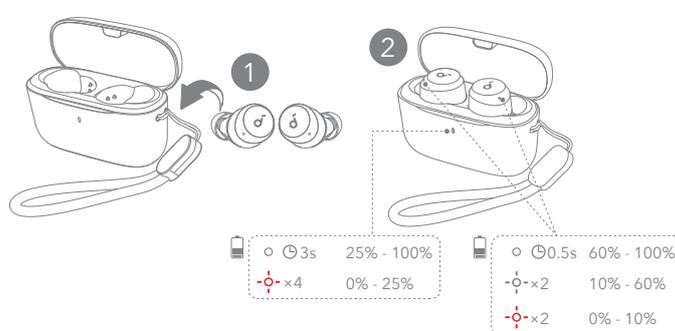

- Luz branca constante
- Luz branca intermitente
- Luz vermelha piscante



## ATUALIZAÇÃO DE FIRMWARE

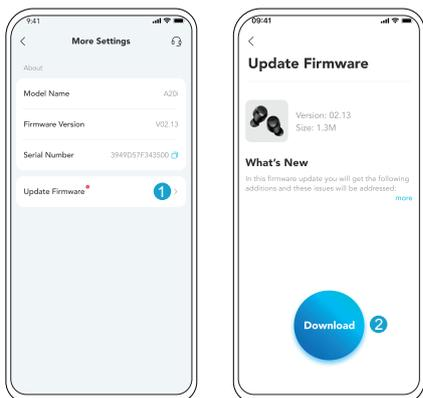

Você será notificado assim que uma nova versão de firmware for detectada quando você conectar os fones de ouvido ao aplicativo. Certifique-se de que os fones de ouvido estejam colocados no estojo de carregamento e que o estojo permaneça aberto até que a atualização do firmware esteja completa. Durante a atualização, certifique-se de que os fones de ouvido estejam sendo carregados e evite qualquer uso.



## ESPECIFICAÇÕES

As especificações estão sujeitas a alterações sem aviso prévio.

Entrada	5V $\overline{\text{---}}$ 0.5A
Potência de saída nominal	5 mW
Capacidade da bateria	60 mAh $\times$ 2 (fones de ouvido); 350Ah (estojo de carregamento)
Tempo de carregamento	Até 2 horas
Reprodução (varia de acordo com o volume e o conteúdo)	Até 9 horas (até 28 horas com o estojo de carregamento)
Unidade de driver	Driver dinâmico de 6mm
Resposta de frequência	20 Hz - 20 kHz
Impedância	16 $\Omega$
Nível de resistência à água (fones de ouvido)	IPX5
Versão do Bluetooth	5.3
Alcance do Bluetooth	10 m/33 pés



## ПРИЛОЖЕНИЕ



Google Play and the Google Play logo are trademarks of Google Inc.



Apple and the Apple logo are trademarks of Apple Inc.



Скачайте приложение Soundcore, чтобы улучшить свой опыт (режим игры, поиск устройства, настройка эквалайзера, обновление прошивки и многое другое). Если наушники не могут подключиться к приложению soundcore, обновите его до последней версии в магазине мобильных приложений.



## НОШЕНИЕ

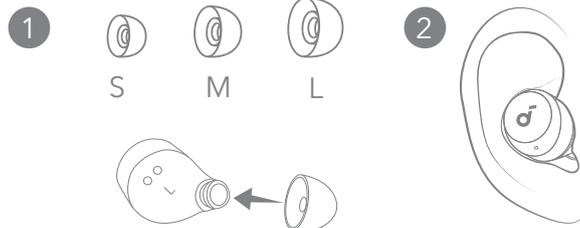

Выберите амбушюры, которые лучше всего подходят для ваших ушей.



## ЗАРЯДКА

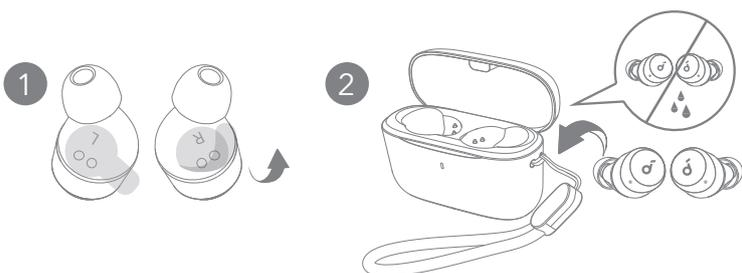

1. Перед первым использованием оторвите изоляционную наклейку с наушников.
  2. Поместите наушники в зарядный футляр и закройте его.
- Полностью высушите наушники и зарядный порт USB-C перед зарядкой.

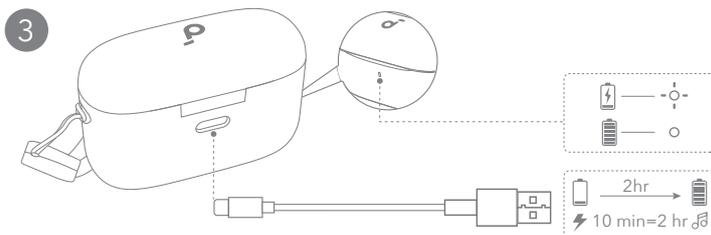

3. Подключите зарядный футляр к источнику питания, используя сертифицированный кабель зарядки USB-C.
- Полностью зарядите как наушники, так и зарядный футляр перед первым использованием.



## ВКЛЮЧЕНИЕ И СОПРЯЖЕНИЕ

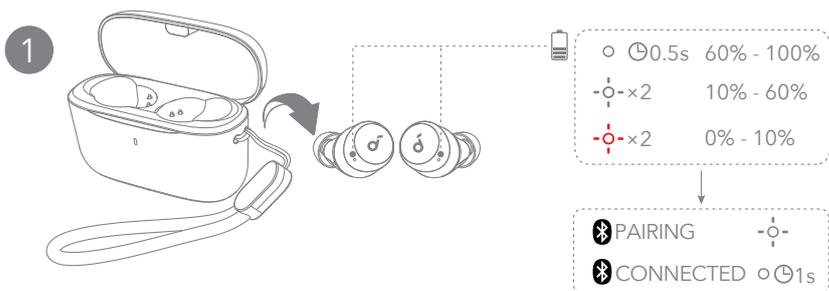

Откройте зарядный футляр и достаньте наушники. Она автоматически включится и войдет в режим сопряжения по Bluetooth.

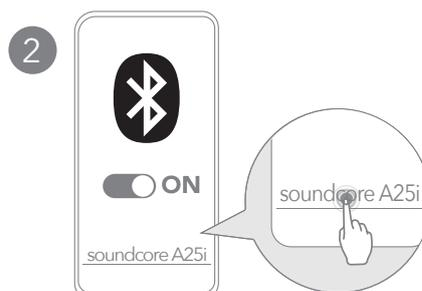

Выберите **"soundcore A20i / A25i"** \* в списке Bluetooth на вашем устройстве при первом подключении.

\* Имя устройства зависит от региона, для которого предназначено устройство.



## СОПРЯЖЕНИЕ ВРУЧНУЮ

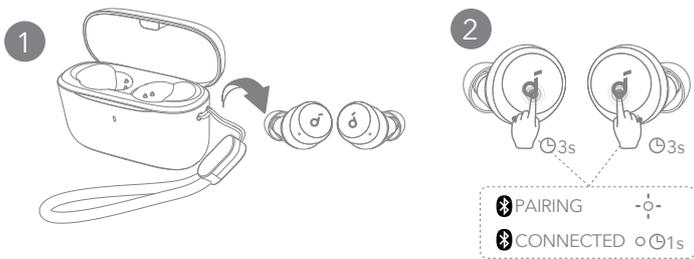

Чтобы вручную войти в режим сопряжения Bluetooth, достаньте наушники из футляра, затем коснитесь и удерживайте сенсорные панели на обоих наушниках в течение 3 секунд, пока индикаторы LED наушников быстро не начнут мигать белым светом.



## ОРГАНЫ УПРАВЛЕНИЯ

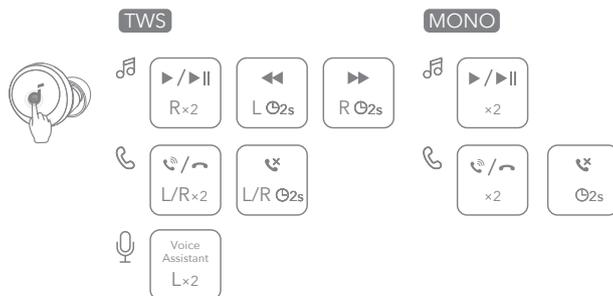

Органы управления также можно настроить в приложении soundcore.



## ОРГАНЫ УПРАВЛЕНИЯ

	Воспроизведение сигнала с аудиовхода	Монофонический режим
Воспроизведение / пауза	Нажмите дважды (П)	Нажмите дважды
Музыкальная иконка	Нажмите и удерживайте 2 секунды (L)	/
Следующая композиция	Нажмите и удерживайте 2 секунды (R)	/
Телефонная иконка	Нажмите дважды (Л/П)	Нажмите дважды
Отклонить звонок	Нажмите и удерживайте 2 с (Л/П)	Нажмите и удерживайте 2 секунды
Микрофонная иконка	Нажмите дважды (Л)	/



## ВЫКЛЮЧЕНИЕ

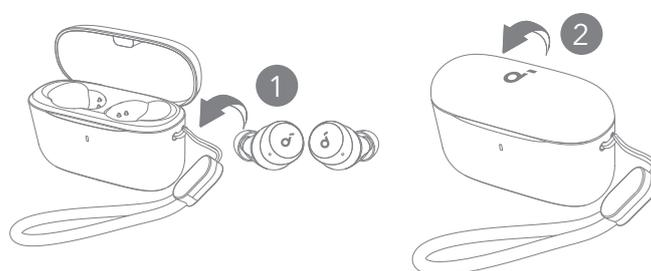

Чтобы выключить наушники, поместите их в зарядный футляр и закройте его. Наушники автоматически выключатся через 30 минут, если они не подключены.



## СБРОС

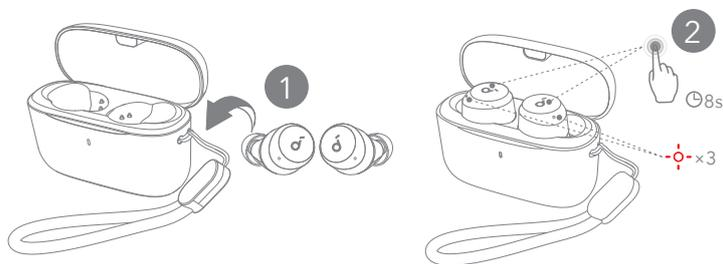

Сбросьте настройки, если наушники не могут соединиться друг с другом или с другими устройствами. Положите наушники в зарядный футляр и оставьте футляр открытым, затем коснитесь и удерживайте сенсорные панели на обоих наушниках в течение 8 секунд, пока светодиодные индикаторы наушников не начнут быстро мигать красным три раза.



## СПРАВКА ПО ИНДИКАЦИИ

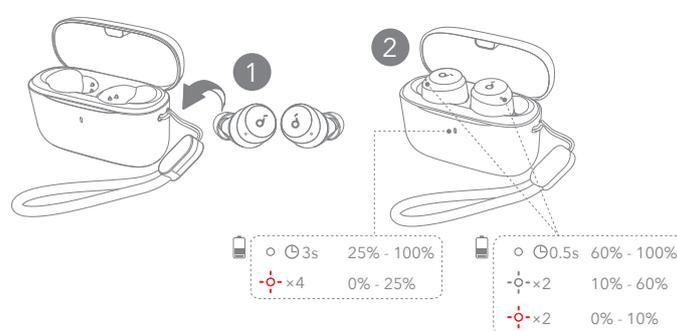

- Горит белым светом
- ◌-◌ Мигает белым светом
- ◌-◌ Мигает красным

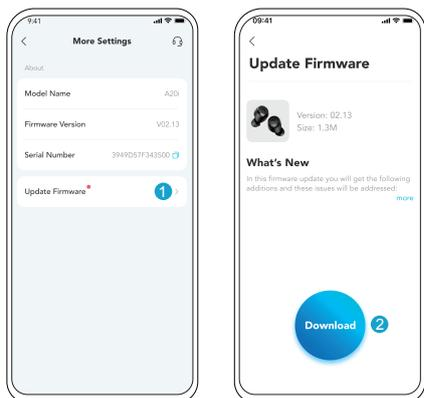

Вы будете уведомлены, как только при подключении наушников к приложению будет обнаружена новая версия прошивки. Убедитесь, что наушники помещены в зарядный футляр, и футляр остается открытым до завершения обновления прошивки. Во время обновления убедитесь, что наушники заряжаются и избегайте использования.

Технические характеристики могут быть изменены без предварительного уведомления.

Вход	5В --- 0,5А
Номинальная мощность выходного сигнала	5 мВт
Емкость аккумулятора	60 мА·ч × 2 (наушники) 350Ач (зарядный футляр)
Время зарядки	До 2 часов
Время воспроизведения (зависит от уровня громкости и воспроизводимого материала)	До 9 часов (до 28 часов с зарядным футляром)
Блок излучателя	6 мм динамический драйвер
Частотная характеристика	20 Гц-20 кГц
Импеданс	16Ω
Степень влагозащиты (наушники)	IPX5
Версия Bluetooth	5.3
Радиус действия Bluetooth	10 м



## APP



Google Play and the Google Play logo are trademarks of Google Inc.



Apple and the Apple logo are trademarks of Apple Inc.



## NOSENIE

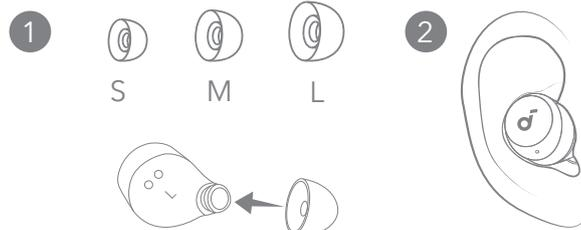

Stiahnite si aplikáciu Soundcore a zlepšite svoje zážitky (herný režim, vyhládanie zariadenia, ladenie ekvalizéra, aktualizácia firmvéru a ďalšie).

Ak slúchadlá nemožno pripojiť k aplikácii soundcore, aktualizujte ju na najnovšiu verziu prostredníctvom obchodu s mobilnými aplikáciami.

Vyberte si vložky do uší, ktoré vám budú najviac vyhovovať.



## NABÍJANIE

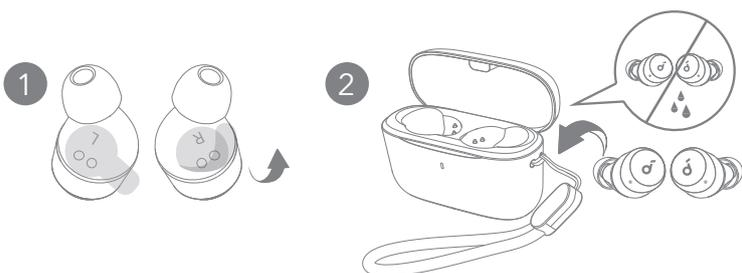

1. Pred prvým použitím zo slúchadiel odtrhnite izolačnú nálepku.
  2. Slúchadlá vložte do nabíjacieho puzdra a zatvorte kryt.
- Pred nabíjaním úplne osušte slúchadlá a nabíjací port USB-C.

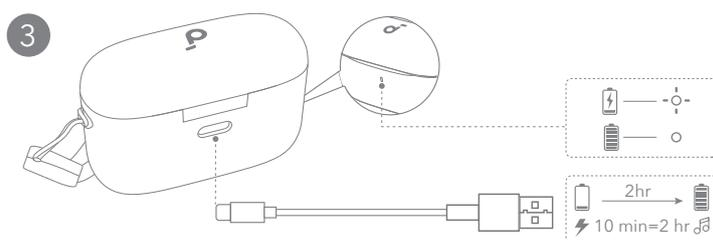

3. Pripojte nabíjacie puzdro k zdroju napájania pomocou certifikovaného nabíjacieho kábla USB-C.
- Pred prvým použitím úplne nabite obe slúchadlá aj nabíjacie puzdro.



## ZAPNUTIE A PÁROVANIE

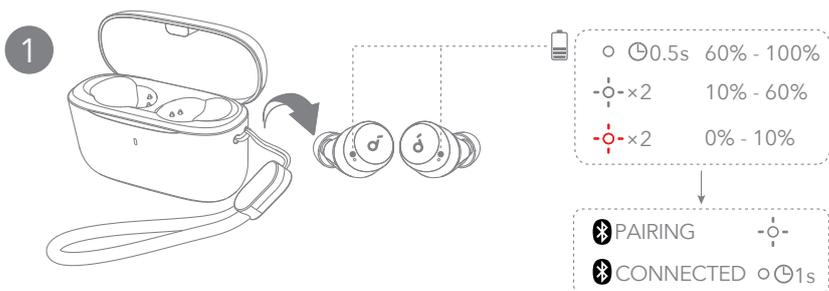

Otvorte nabíjacie puzdro a vyberte slúchadlá. Automaticky sa zapnú a prejdú do režimu párovania prostredníctvom pripojenia Bluetooth.

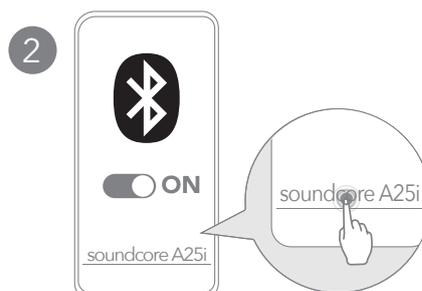

Pri prvom pripojení vyberte v zozname zariadení Bluetooth položku „**soundcore A20i/A25i**“ \*.

\*Názov zariadenia sa môže líšiť v závislosti od regiónu.



## MANUÁLNE PÁROVANIE

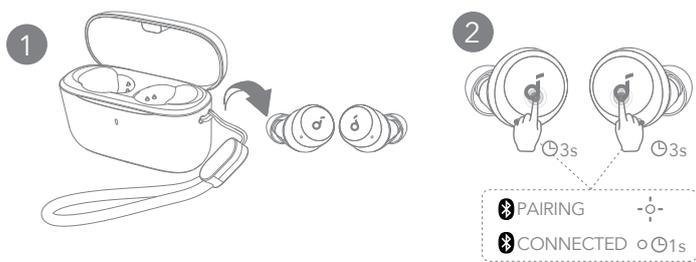

Ak chcete manuálne vstúpiť do režimu párovania Bluetooth, vyberte slúchadlá z puzdra a potom ťuknite a podržte dotykové plochy na oboch slúchadlách na 3 sekundy, kým LED indikátory slúchadiel nezačnú rýchlo blikať na bielo.



## OVLÁDANIE

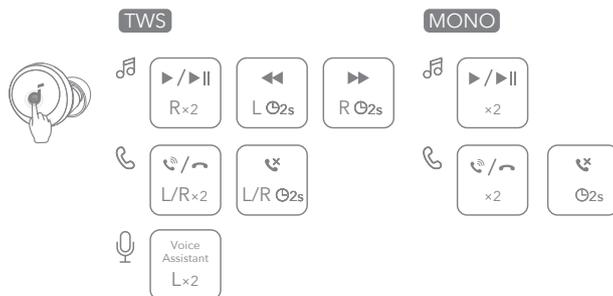

Ovládacie prvky si môžete prispôbiť aj v aplikácii soundcore.



## OVLÁDANIE

	Režim TWS	Režim mono
Prehrávanie/ pozastavenie	Dvojité ťuknutie (P)	Ťuknite dvakrát
Predošlá skladba	Ťuknutie a podržanie na 2 sekundy (L)	/
Ďalšia skladba	Ťuknutie a podržanie na 2 sekundy (R)	/
Prijatie/ukončenie hovoru	Dvojité ťuknutie (L/P)	Ťuknite dvakrát
Odmietnutie hovoru	Ťuknite a podržte stlačené 2 s (L/P)	Ťuknutie a podržanie na 2 sekundy
Aktivácia softvéru hlasového asistenta	Dvojité ťuknutie (L)	/



## VYPNUTIE

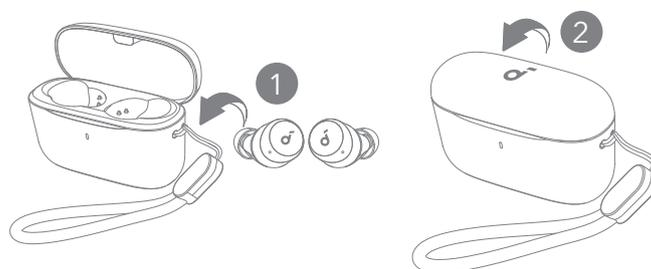

Ak chcete slúchadlá vypnúť, vráťte ich do nabíjacieho puzdra a zatvorte ho.

Ak nie sú slúchadlá pripojené, po 30 minútach sa automaticky vypnú.



## RESETOVANIE

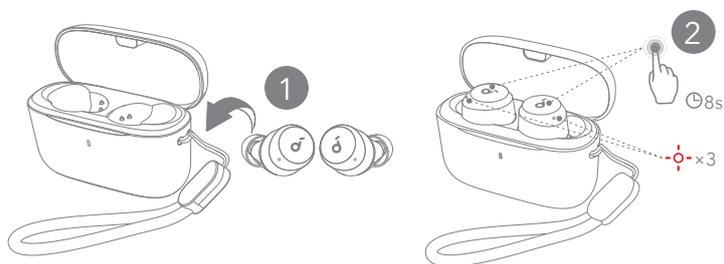

Ak majú slúchadlá problémy so spárovaním navzájom alebo s inými zariadeniami, resetujte ich. Vložte slúchadlá do nabíjacieho puzdra a nechajte puzdro otvorené, následne ťuknite na dotykové plochy na oboch slúchadlách a podržte ich 8 sekúnd, kým LED indikátory slúchadiel trikrát rýchlo nezablikajú na červeno.



## LED SVETELNÝ SPRIEVODCA

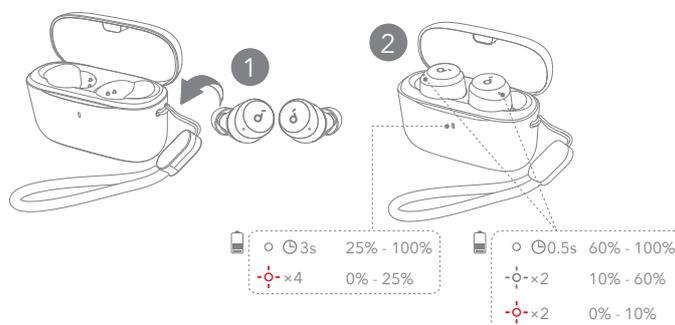

- Trvalo rozsvietená biela
- Utripa belo
- Blikať na červeno

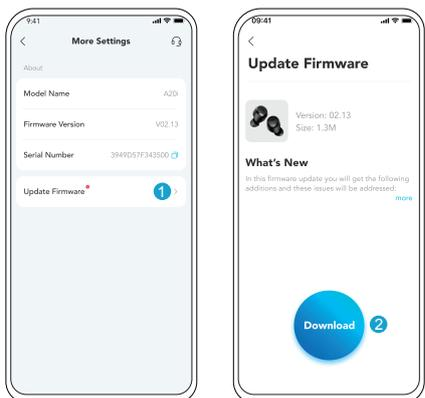

Po pripojení slúchadiel k aplikácii dostanete upozornenie, akonáhle bude k dispozícii nová verzia firmvéru. Uistite sa, že sú slúchadlá vložené do nabíjacieho puzdra a že puzdro zostane otvorené až do dokončenia aktualizácie firmvéru. Počas aktualizácie sa uistite, že sa slúchadlá nabíjajú a nepoužívajte ich.

Technické údaje sa môžu bez oznámenia zmeniť.

Vstup	5 V $\overline{\text{---}}$ 0,5 A
Menovitý výstupný výkon	5 mW
Kapacita batérie	60 mAh $\times$ 2 (slúchadlá); 350 Ah (nabíjacie puzdro)
Doba nabíjania	Max. 2 hodiny
Doba prehrávania (líši sa podľa úrovne hlasitosti a obsahu)	Až 9 hodín (až 28 hodín s nabíjacím puzdrom)
Menič	6 mm dynamický menič
Odpovedná frekvencia	20 Hz - 20 kHz
Impedancia	16 $\Omega$
Úroveň vodotesnosti (slúchadlá)	IPX5
Verzia Bluetooth	5.3
Dosah Bluetooth	10 m/33 stôp



## APLIKACIJA



Google Play and the Google Play logo are trademarks of Google Inc.



Apple and the Apple logo are trademarks of Apple Inc.



Prenesite aplikacijo Soundcore za izboljšanje vaše izkušnje (igralni način, iskanje naprave, nastavitve EQ, posodobitev vdelane programske opreme in še več). Če se slušalki ne moreta povezati z aplikacijo soundcore, jo posodobite na najnovejšo različico v trgovini z mobilnimi aplikacijami.



## UPORABA

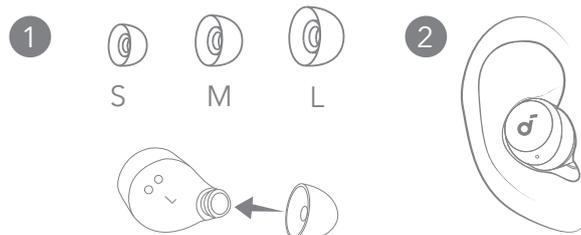

Izberite ušesna vstavka, ki se najboljše prilegata obliki vašega ušesa.



## POLNJENJE

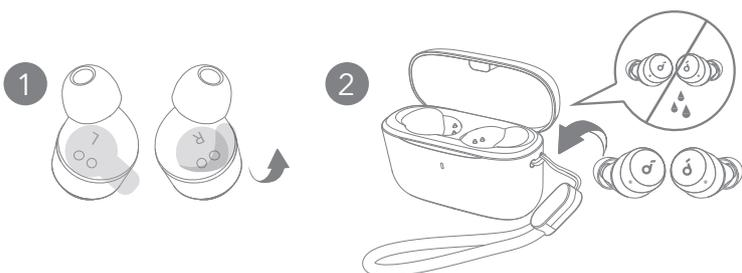

1. Pred prvo uporabo odstranite izolacijsko nalepko s slušalk.
  2. Slušalki vstavite v etui za polnjenje in ga zaprite.
- Pred polnjenjem popolnoma osušite slušalki in polnilni kabel USB-C.

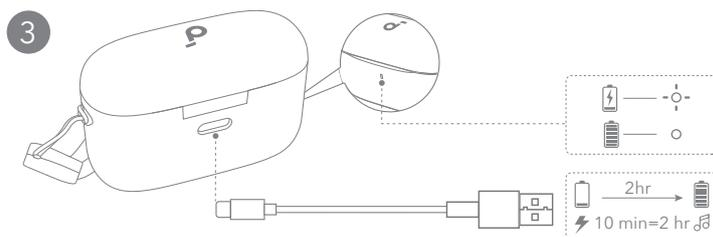

3. Polnilni etui povežite z napajalnikom s pomočjo certificiranega polnilnega kabla USB-C.
- Pred prvo uporabo popolnoma napolnite tako slušalki kot tudi polnilno ohišje.

## VKLOP IN SEZNANJANJE

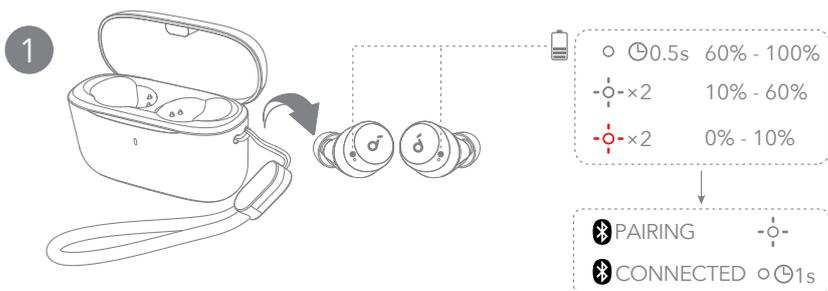

Odprite polnilni etui in vzemite slušalki. Očala se bodo samodejno vklopila in preklopila v način za seznanjanje prek povezave Bluetooth.

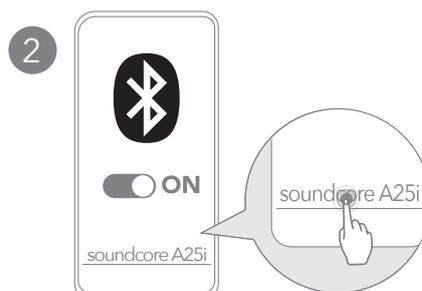

Pri prvem povezovanju izberite **"soundcore A20i / A25i"** \* na seznamu naprav Bluetooth vaše naprave.  
\*Ime naprave se morda razlikuje glede na regijo.



# ROČNO SEZNANJANJE

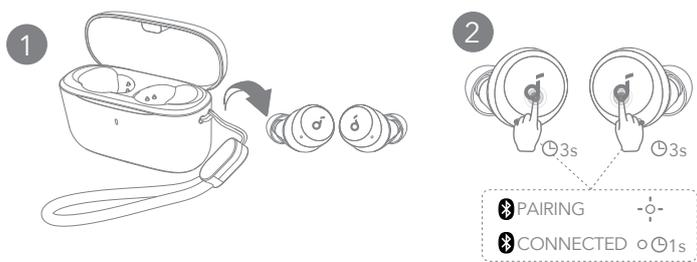

Za ročni vstop v način seznanjanja Bluetooth vzemite slušalke iz etuija, nato tapnite in držite na dotik občutljive ploščice na obeh slušalkah 3 sekunde, dokler LED indikatorji slušalk ne začnejo hitro utripati bele barve.



# KONTROLNIKI

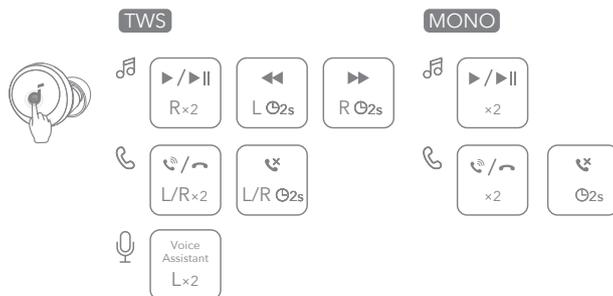

Kontrolnike lahko prilagodite tudi v aplikaciji soundcore.



# KONTROLNIKI

	Način TWS	Način Mono
Predvajaj/ustavi	Dvakrat tapnite (R)	Dvotap
Prejšnja skladba	Tapnite in držite 2 sekundi (L)	/
Naslednja skladba	Tap and hold for 2 seconds (D)	/
Odgovori/končaj klic	Dvakrat tapnite (L/D)	Dvotap
Zavrni klic	Tapnite in zadržite 2 sekundo (L/R)	Tapnite in držite 2 sekundi.
Vklop glasovnega pomočnika	Dvakrat tapnite (L)	/



# IZKLOP

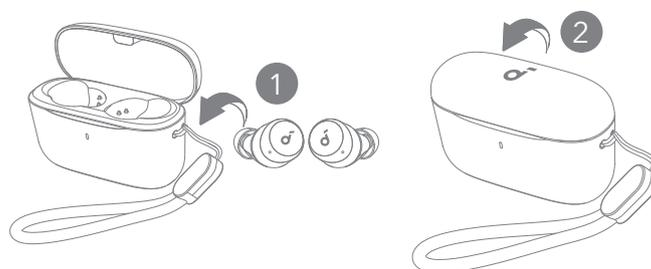

Če želite izklopiti slušalki, ju vrnite v etui za polnjenje in ga zaprite. Če niso povezane, se bodo slušalke samodejno izklopile po 30 minutah.



# PONASTAVITEV

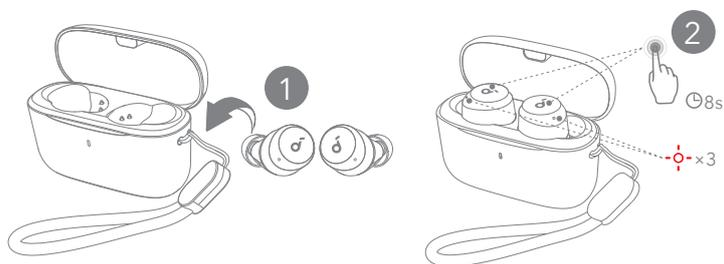

Ponastavite, če se slušalki ne moreta povezati med seboj ali z drugimi napravami. Postavite slušalke v polnilni etui in pustite etui odprt, nato pritisnite in držite na dotik občutljivi ploščici na obeh slušalkah 8 sekund, dokler LED indikatorji slušalk trikrat hitro ne zasvetijo rdeče.



# LED SVETLOVODNIK

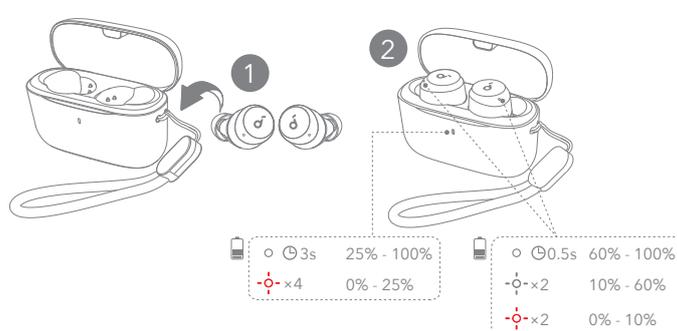

- Sveti belo
- Blikajúca biela
- Utripa rdeče



## POSODOBITEV VDELANE PROGRAMSKE OPREME



## SPECIFIKACIJE

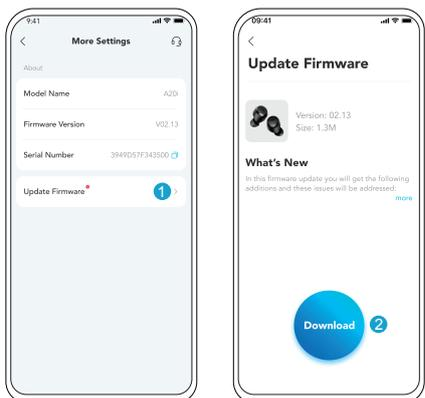

Ko slušalke povežete z aplikacijo, boste obveščeni, ko se odkrije nova različica vdelane programske opreme. Poskrbite, da so slušalke v polnilnem ohišju in da ostane ohišje odprto, dokler se ne konča posodobitev programske opreme. Med posodobitvijo poskrbite, da se slušalke polnijo in se izogibajte uporabi.

Tehnični podatki se lahko spremenijo brez predhodnega obvestila.

Vhod	5V $\overline{\text{---}}$ 0,5 A
Ocenjena izhodna moč	5 mW
Zmogljivost baterije	60 mAh $\times$ 2 (slušalki); 350 Ah (polnilni etui)
Čas polnjenja	Do 2 uri
Čas predvajanja (odvisno od stopnje glasnosti in vsebine)	Do 9 ur (do 28 ur s polnilnim etuijem)
Pogonska enota	6-milimetrski dinamični gonilnik.
Frekvenca odziva	20 Hz-20 kHz
Impedanca	16 $\Omega$
Stopnja vodoodpornosti (slušalke)	IPX5
Različica Bluetooth	5.3
Domet Bluetooth	10 m/33 ft



## APP



Google Play and the Google Play logo are trademarks of Google Inc.



Apple and the Apple logo are trademarks of Apple Inc.



Ladda ner soundcore-appen för att förbättra din upplevelse (spel-läge, hitta enhet, EQ-justering, firmware-uppdatering och mer). Om dina öronsnäckor inte lyckas ansluta till soundcore-appen uppdaterar du appen till den senaste versionen via appbutiken för din mobila enhet.



## ANVÄNDNING

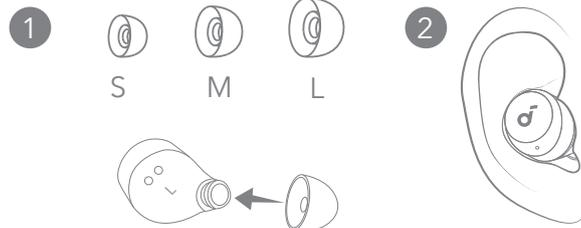

Välj de hörsnäckor som passar dina öron bäst.



## LADDNING

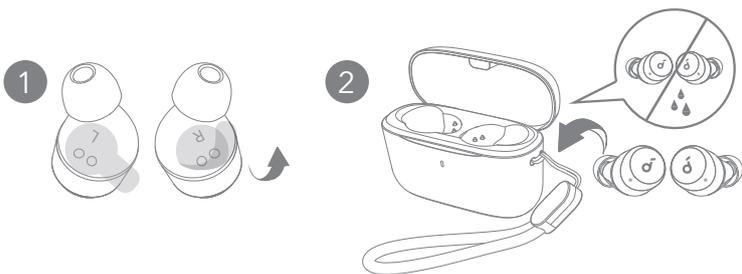

1. Dra loss den isolerande etiketten från varje öronsnäcka innan du använder den första gången.
2. Placera öronsnäckorna i laddningsfodralet och stäng det.
  - Torka öronsnäckorna och USB-C-laddningsporten torra innan laddning.

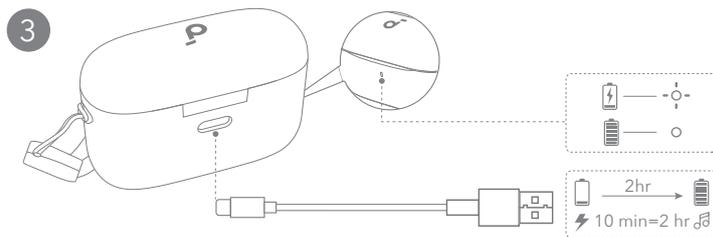

3. Anslut laddningsetuiet till en strömkälla genom att använda en certifierad USB-C-laddningskabel.
  - Ladda helt upp både öronsnäckorna och laddningsfodralet innan första användningen.

## SLÅ PÅ OCH PARKOPPLING

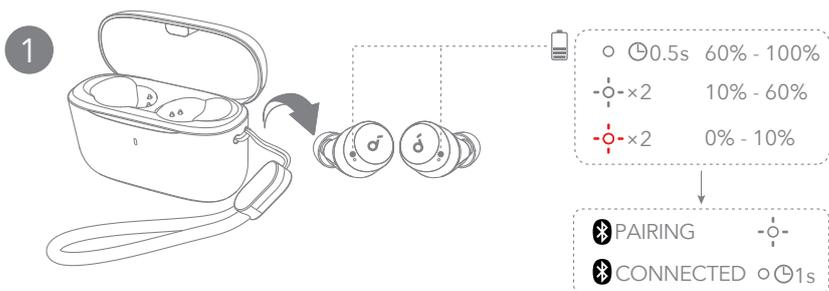

Öppna laddningsfodralet och ta ut öronpropparna. De slås på och går in i Bluetooth-parkopplingsläge automatiskt.

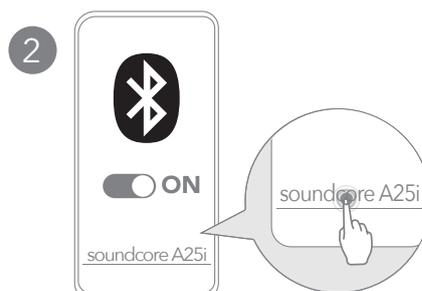

Välj **"soundcore A20i/A25i"** \* på din enhets Bluetooth-lista när du ansluter för första gången.

\*Enhetsnamnet kan variera beroende på region.



# MANUELL PARKOPPLING

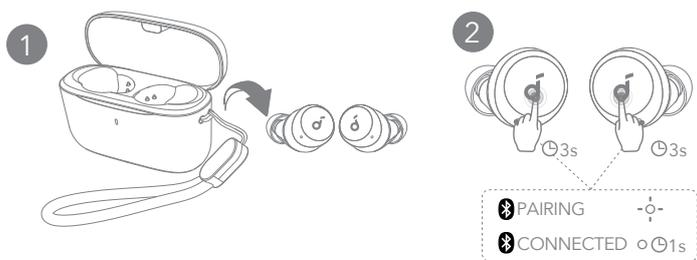

För att manuellt aktivera Bluetooth-parkopplingsläge, ta ut öronpropparna ur fodralet och tryck sedan och håll ned touchpads på båda öronpropparna i 3 sekunder tills öronpropparnas LED-indikatorer blinkar vitt snabbt.



# KONTROLLER

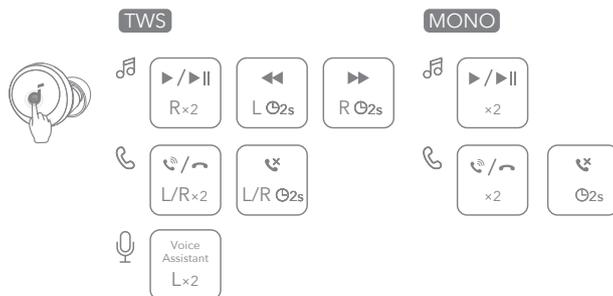

Du kan även anpassa kontrollerna i Soundcore-appen.



# KONTROLLER

	TWS-läge	Monoläge
	Spela upp/pausa	Tryck två gånger (R)
	Föregående spår	Håll intryckt i två sekunder (V)
	Nästa spår	Håll intryckt i två sekunder (H)
	Besvara/avsluta ett samtal	Tryck två gånger (L/R)
	Avvisa ett samtal	Håll intryckt i 2 sekunder (L/R)
	Aktivera programvara för röstassistent	Tryck två gånger (L)



# AVSTÄNGNING

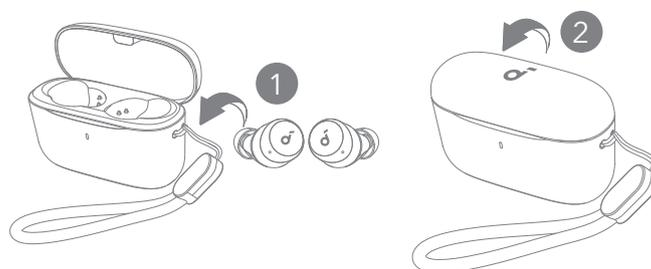

Du stänger av öronsnäckorna genom att placera dem i laddningsfodralet och stänger det. Öronsnäckorna kommer automatiskt att stängas av efter 30 minuter om de inte är anslutna.



# ÅTERSTÄLLNING

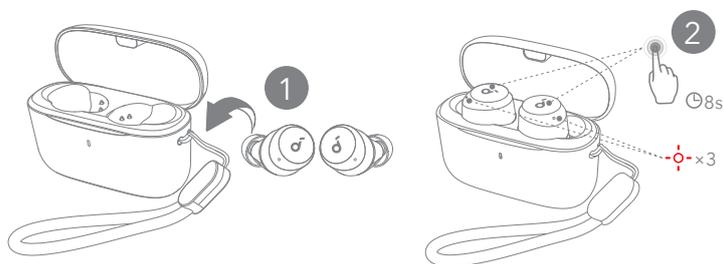

Återställ öronsnäckorna om de inte kan parkopplas med varandra eller andra enheter. Placera öronpropparna i laddningsfodralet och lämna fodralet öppet, tryck sedan och håll in touchpads på båda öronpropparna i 8 sekunder tills öronpropparnas LED-indikatorer blinkar rött snabbt tre gånger.



# LED-LJUSGUIDE

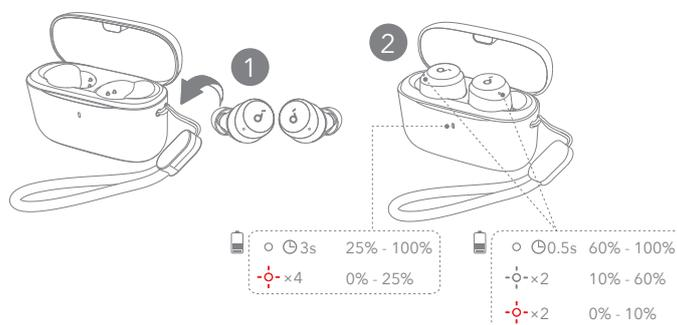

- Lyser vitt
- Blinkar vitt
- Blinkar rött



## UPPDATERING AV DEN FASTA PROGRAMVARAN

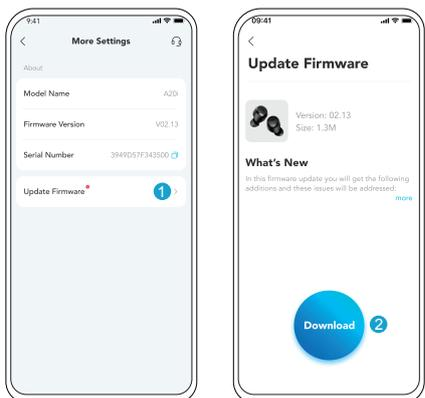

Du kommer att meddelas när en ny firmware-version upptäcks när du ansluter öronsnäckorna till appen. Se till att öronpropparna placeras i laddningsfodralet och att fodralet förblir öppet tills firmware-uppdateringen är klar. Under uppdateringen, se till att öronpropparna laddas och undvik all användning.



## SPECIFIKATIONER

\*Specifikationerna kan ändras utan föregående meddelande.

Ingång	5 V $\overline{\text{---}}$ 0,5 A
Nominell uteffekt	5 mW
Batterikapacitet	60 mAh $\times$ 2 (öronsnäckor); 350 Ah (laddningsväska)
Laddningstid	Upp till 2 timmar
Speltid (varierar beroende på volymnivå och innehåll)	Upp till 9 timmar (upp till 28 timmar med laddningsfodralet)
Högtalarelement	6 mm dynamisk drivrutin
Frekvensåtergivning	20 Hz-20 kHz
Impedans	16 $\Omega$
Vattentäthetsklassning (öronsnäckor)	IPX5
Bluetooth-version	5.3
Bluetooth-räckvidd	10 m



# APP



# TAKMA



Google Play and the Google Play logo are trademarks of Google Inc.



Apple and the Apple logo are trademarks of Apple Inc.

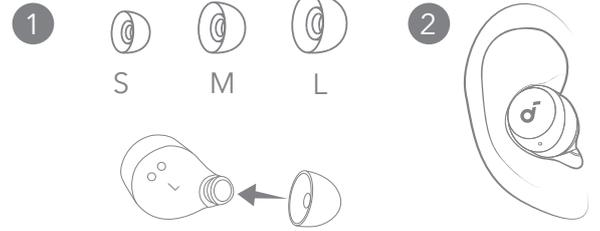

Deneyiminizi geliřtirmek (Oyun modu, Cihaz bulma, EQ ayarı, Üretici Yazılımı güncellemesi ve daha fazlası) için Soundcore uygulamasını indirin .  
Kulaklığınız soundcore uygulamasına bağlanamıyorsa mobil uygulama mağazanızda uygulamayı en son sürüme güncelleyin.

Kulağınıza en uygun kulaklık uçlarını seçin.



## ŞARJ ETME

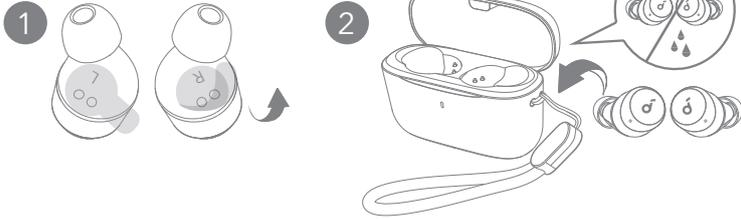

1. Kulaklıkları ilk kez kullanmadan önce üzerindeki yalıtım etiketini çıkarın.
  2. Kulaklıkları şarj kutusuna yerleştirin ve kutuyu kapatın.
- Şarj etmeden önce kulaklıkları ve USB-C bağlantı noktasını tamamen kurutun.

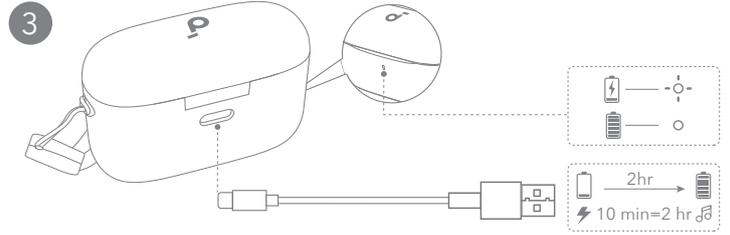

3. Ürünle birlikte verilen sertifikalı USB-C şarj kablosunu kullanarak şarj kutusunu güç kaynağına bağlayın.
- İlk kullanım öncesinde hem kulaklıkları hem de şarj kutusunu tamamen şarj edin.



## AÇMA VE EŞLEŞTİRME

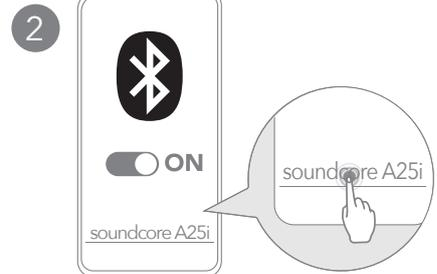
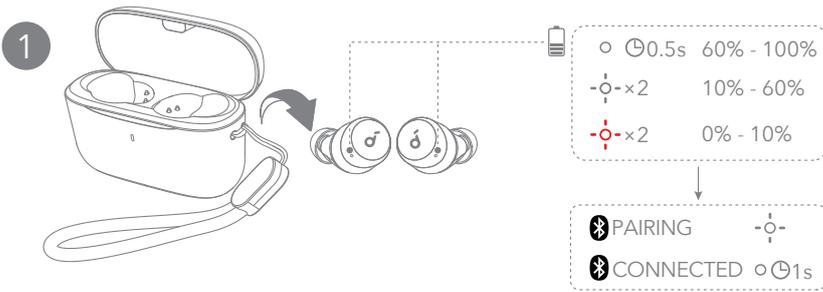

Şarj kutusunu açın ve kulaklıkları çıkarın. Otomatik olarak açılır ve Bluetooth eşleşme moduna girer.

İlk kez bağlandığınızda cihazınızın Bluetooth listesinde "**soundcore A20i / A25i**"'yi \* seçin.

\*Cihaz adı, bölgeye göre değişiklik gösterebilir.



## MANUEL EŞLEŞTİRME

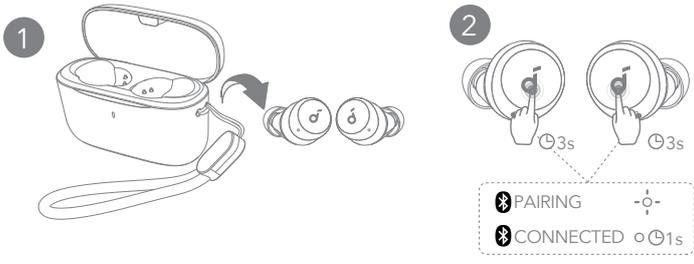

Bluetooth eşleştirme modunu manuel olarak etkinleştirmek için kulaklıkları kutusundan çıkarın, ardından her iki kulaklığın dokunmatik yüzeylerine 3 saniye boyunca basılı tutun, kulaklıkların LED göstergeleri hızlı bir şekilde beyaz yanıp söner.



## KONTROLLER

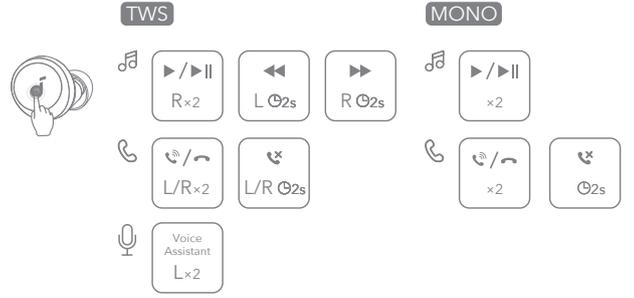

Ayrıca kontrolleri soundcore uygulamasında özelleştirebilirsiniz.



## KONTROLLER

	TWS modu	Mono mod
Oynatma/Duraklatma	Çift dokunun (R)	Çift dokunun
Önceki parça	2 saniye süreyle basılı tutun (Sol)	/
Sonraki parça	2 saniye süreyle basılı tutun (Sağ)	/
Aramayı yanıtlama / Sonlandırma	Çift dokunun (L/R)	Çift dokunun
Aramayı reddetme	2 saniye süreyle basılı tutun (L/R)	2 saniye süreyle basılı tutun
Sesli asistan yazılımını etkinleştir	Çift dokunun (L)	/



## KAPATMA

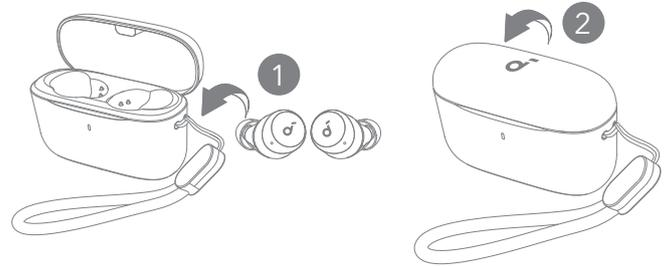

Kapatmak için kulaklıkları şarj kutusuna geri yerleştirin ve kutuyu kapatın. Kulaklıklar bağlı değilse, 30 dakika sonra otomatik olarak kapanacaktır.



## SIFIRLAMA

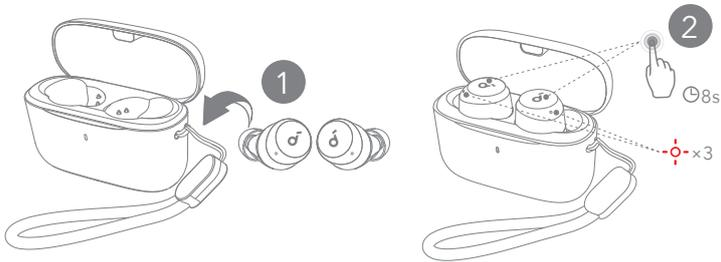

Kulaklıkların birbirleriyle veya diğer cihazlarla eşleştirilmesiyle ilgili sorun oluşursa sıfırlayın. Kulaklıkları şarj kutusuna yerleştirin ve kutuyu açık bırakın, ardından kulaklıkların LED göstergeleri hızlıca üç kez kırmızı yanıp söne kadar her iki kulaklığın dokunmatik yüzeylerine 8 saniye boyunca basılı tutun.



## LED IŞIK KILAVUZU

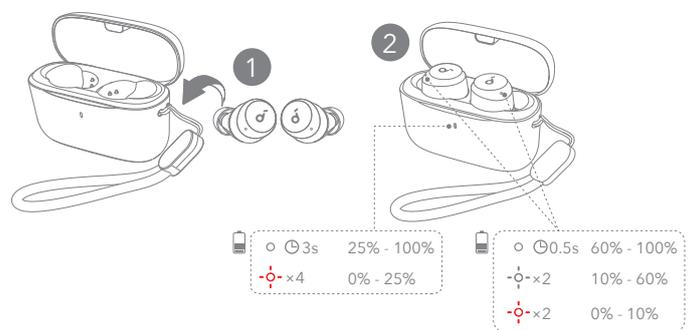

- Sabit yanıp beyaz
- Yanıp sönen beyaz
- Yanıp sönen kırmızı

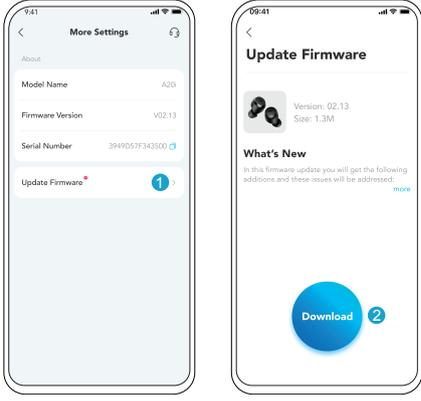

Kulaklıkları uygulamaya bağladığınızda yeni bir üretici yazılımı sürümü tespit edildiğinde size bildirim gönderilecektir. Kulaklıkların şarj kutusuna yerleştirildiğinden ve üretici yazılımı güncellemesi tamamlanana kadar kutunun açık kaldığından emin olun. Güncelleme sırasında kulaklıkların şarj edildiğinden emin olun ve kulaklıkları kullanmayın.

Teknik özellikler önceden bildirilmeksizin değiştirilebilir.

Giriş	5 V --- 0,5A
Nominal çıkış gücü	5 mW
Pil kapasitesi	60 mA/sa × 2 (kulaklıklar); 350 Ah (şarj kutusu)
Şarj süresi	2 saate kadar
Çalma süresi (ses seviyesine ve içeriğe göre değişiklik gösterir)	9 saate kadar (şarj kutusuyla birlikte 28 saate kadar)
Sürücü ünitesi	6 mm dinamik sürücü
Frekans yanıtı	20 Hz - 20 kHz
Empedans	16Ω
Su geçirmezlik seviyesi (kulaklık)	IPX5
Bluetooth sürümü	5.3
Bluetooth aralığı	10 m / 33 ft



## アプリ



Google Play and the Google Play logo are trademarks of Google Inc.



Apple and the Apple logo are trademarks of Apple Inc.



Soundcore アプリをダウンロードすると、モードの切り替えや「イヤホンを探す」機能、イコライザー設定、ファームウェアの更新など、より充実した機能をご利用いただけます。イヤホンが Soundcore アプリに接続できない場合は、アプリストアから最新のバージョンに更新してください。



## 装着

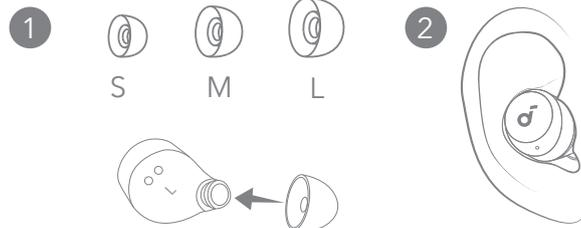

耳のサイズに合うイヤーチップを選択します。



## 充電

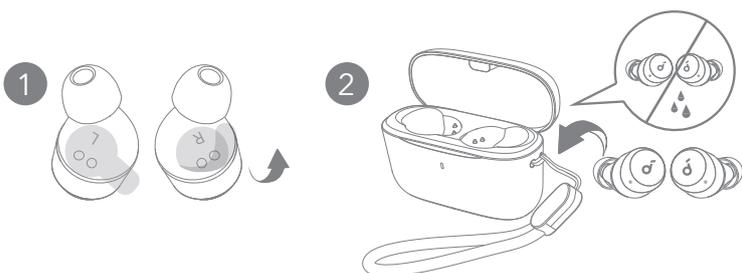

- 初めてご使用になる前に、イヤホンの保護シールをはがしてください。
- 充電ケースに両方のイヤホンを入れ、充電ケースを閉じます。
  - イヤホンと USB ポートに水や汗が付着している場合は、完全に乾かしてから充電してください。

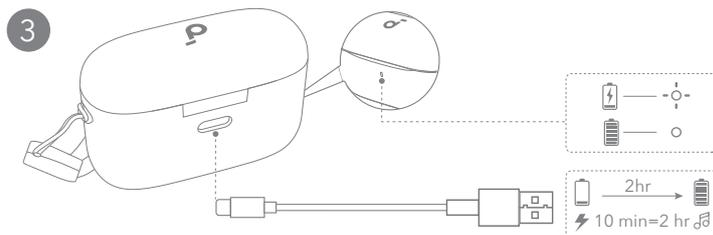

3. 損傷を防ぐため、付属の USB-C ケーブルを使用してください。
  - 初めてご使用になる前に、両方のイヤホンと充電ケースを満充電にしてください。



## 電源オンとペアリング

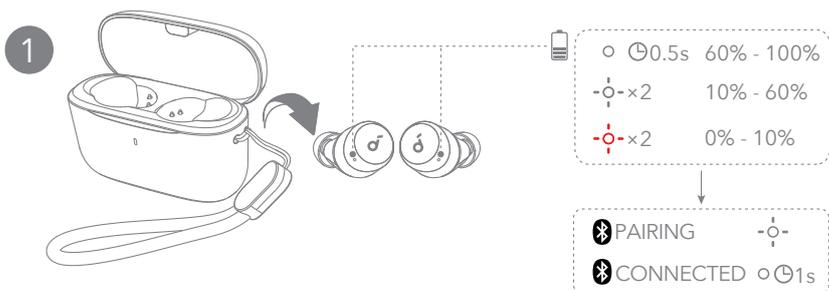

充電ケースを開いてイヤホンを取り出すと、両方のイヤホンの電源が自動的にオンになり、Bluetooth ペアリングモードになります。

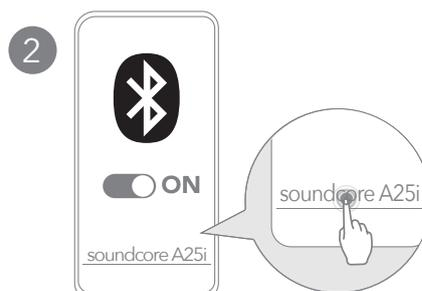

初めてご利用になる際は、ご使用の機器の Bluetooth 設定画面で「Soundcore A25i」を選択し、接続してください。

# Bluetooth 手動ペアリング

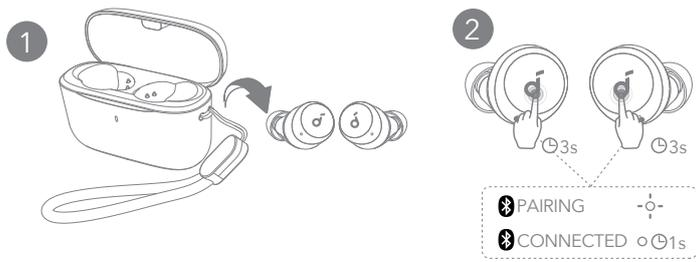

手動で Bluetooth ペアリングモードを開始するには、イヤホンを充電ケースから取り出し、両方のイヤホンのタッチパッドを3秒間長押しし、イヤホンのLEDインジケータが白色ですばやく点滅するまで待ちます。

# 操作方法

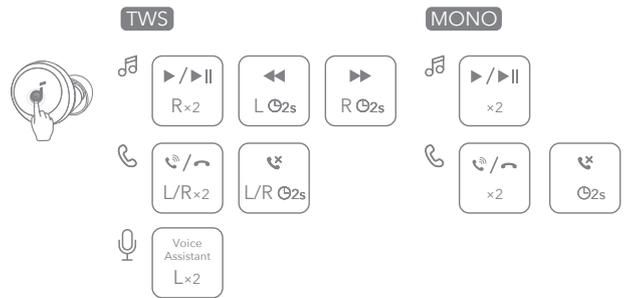

タッチ操作は、Soundcore アプリでカスタマイズすることもできます。

※ TWS (TWS モード) : 両耳使用時

※ MONO (モノラルモード) : 片耳使用時

# 操作方法

	TWS モード	モノラルモード
再生 / 一時停止	2 回タップ (右)	2 回タップ
戻る	2 秒間長押し (左)	/
次へ	2 秒間長押し (右)	/
着信に応答 / 通話を終了	2 回タップ (左 / 右)	2 回タップ
着信を拒否	2 秒間長押し (左 / 右)	2 秒間長押し
Siri などの音声アシスタントを起動	2 回タップ (左)	/

※上記はデフォルトの設定です。タッチ操作は Soundcore アプリでカスタマイズすることができます。

# 電源オフ

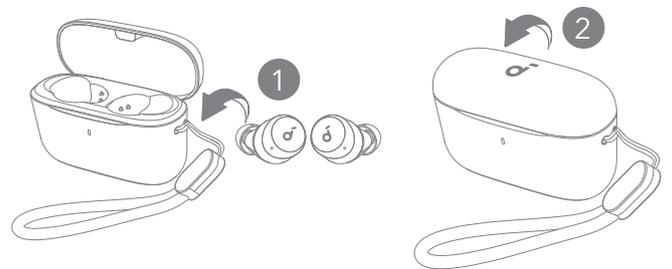

充電ケースに両方のイヤホンを戻してケースを閉じると、イヤホンの電源は自動的にオフになります。イヤホンが接続されていない状態で30分経過すると、電源は自動でオフになります。

# リセット

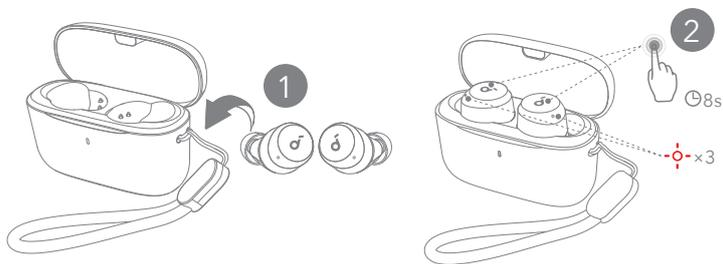

片耳からしか音が聞こえない場合やイヤホンと機器を適切に接続できない場合は、本製品のリセットを行ってください。リセットを行うには、充電ケースに両方のイヤホンを戻します。充電ケースを開けたまま両方のイヤホンのタッチパッドを8秒間長押しし、イヤホンのLEDインジケータが赤色ですばやく3回点滅するまで待ちます。

# LED インジケーター

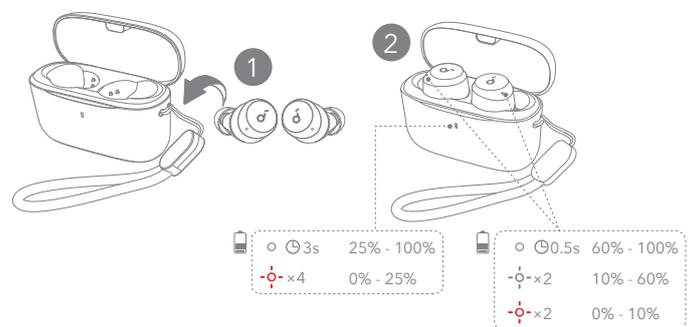

○ 白色で点灯

○ 白色で点滅

○ 赤色で点滅



## ファームウェアの更新

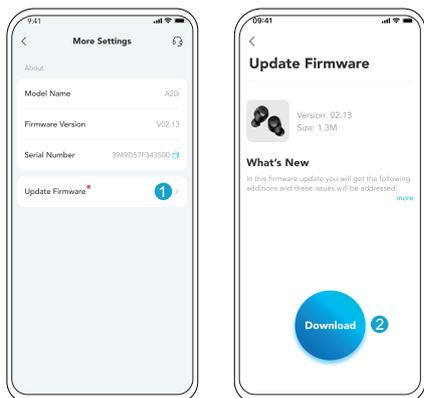

イヤホンをアプリに接続した際に新しいファームウェアバージョンが検出されると、通知されます。アプリの指示に従って最新の状態に更新してください。更新する際は両方のイヤホンを充電ケースに戻し、ファームウェアの更新が完了するまでケースを開いたままにしてください。更新中は、両方のイヤホンが充電状態であることを確認し、いずれの操作も行わないでください。



## 製品の仕様

仕様は予告なく変更されることがあります。

入力	5V --- 0.5A
定格出力	5 mW
バッテリー容量 (mAh)	60 mAh ( × 2 ) ( イヤホン ) 350 mAh ( 充電ケース )
充電時間	最大 2 時間
再生可能時間 ( 音量や再生コンテンツにより異なる )	最大 9 時間 ( 充電ケースを使用した場合、最大 28 時間 )
ドライバーユニット	6mm ダイナミックドライバー
周波数応答	20 Hz ~ 20 kHz
電気抵抗	16 Ω
防水規格	IPX5 ( イヤホン本体のみ )
通信方式	Bluetooth 5.3
Bluetooth 動作範囲	10m



# 앱



Google Play and the Google Play logo are trademarks of Google Inc.



Apple and the Apple logo are trademarks of Apple Inc.



경험을 향상시키기 위해 사운드코어 앱을 다운로드하세요 ( 게임 모드 , 기기 찾기 , EQ 튜닝 , 펌웨어 업데이트 등 ). 이어버드를 soundcore 앱과 연결할 수 없는 경우 모바일 앱 스토어에서 최신 버전으로 업데이트하십시오 .



# 착용하기

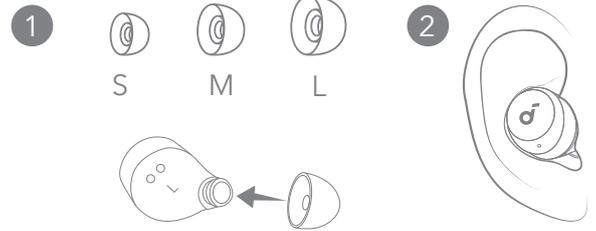

귀에 가장 잘 맞는 이어팁을 선택합니다 .



# 충전하기

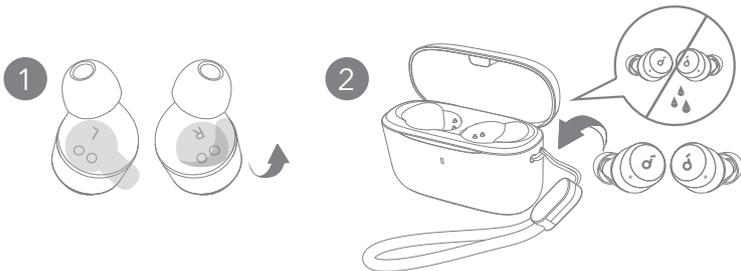

1. 처음 사용하는 경우 이어버드에 부착된 절연 스티커를 먼저 떼어냅니다 .
  2. 이어버드를 충전 케이스에 넣고 뚜껑을 닫습니다 .
- 충전하기 전에 이어버드와 USB C 충전 포트를 완전히 건조시킵니다 .

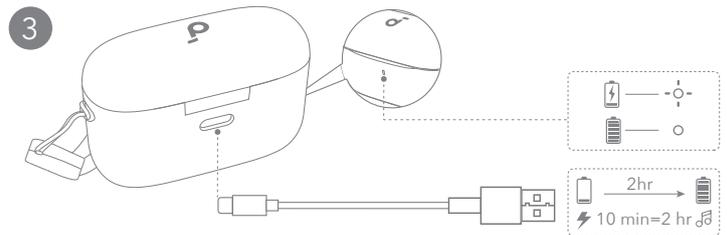

3. 정품 USB-C 충전 케이블을 사용하여 충전 케이스를 전원 공급원에 연결하세요 .
- 처음 사용하기 전에 이어버드와 충전 케이스를 모두 완전히 충전하세요 .



# 전원 켜기 및 페어링하기

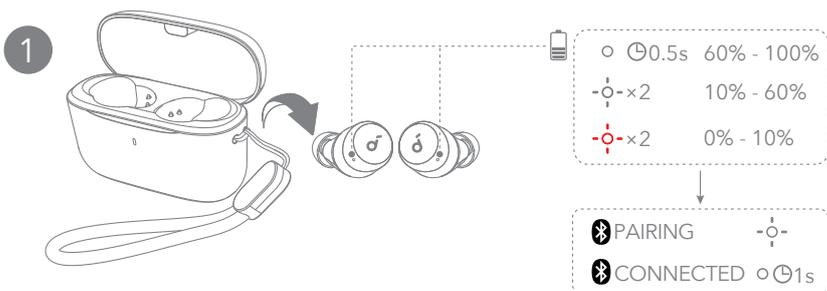

충전 케이스를 열고 이어버드를 꺼내세요 . 그러면 자동으로 전원이 켜지고 Bluetooth 페어링 모드로 들어갑니다 .

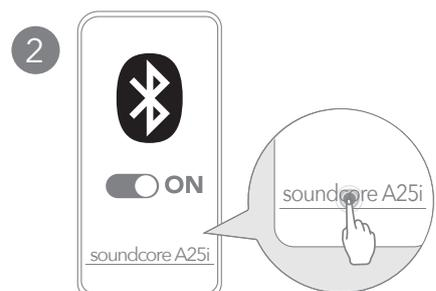

처음 연결할 때 기기의 블루투스 목록에서 "soundcore A20i / A25i" \* 를 선택하세요 .

\* 디바이스 이름은 지역에 따라 다를 수 있습니다 .

# 수동 페어링

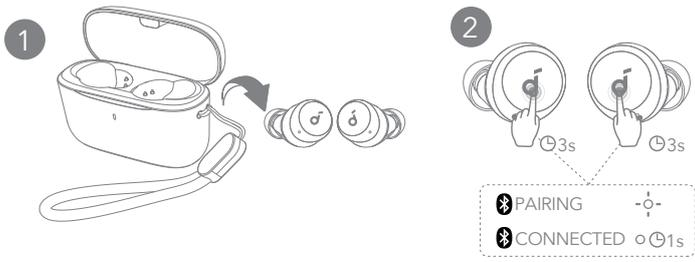

수동으로 Bluetooth 페어링 모드로 들어가려면 이어버드를 케이스에서 꺼내고, 그런 다음 양쪽 이어버드의 터치패드를 3초 동안 누르고 있으면 이어버드의 LED 표시등이 빠르게 흰색으로 깜박입니다.

# 컨트롤

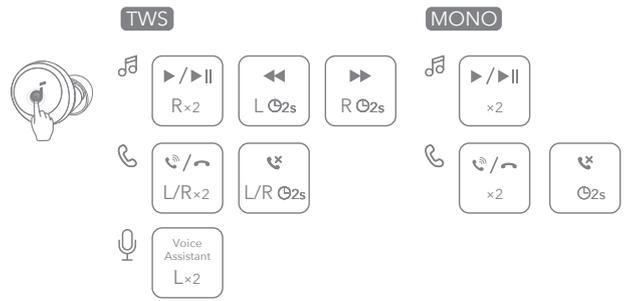

컨트롤은 soundcore 앱에서 사용자 지정할 수 있습니다.

# 컨트롤

	TWS 모드	모노 모드
재생 / 일시중지	두 번 탭합니다 (R).	두 번 탭합니다 .
이전 트랙	2 초간 길게 누르기 (L)	/
다음 트랙	2 초간 길게 누르기 (R)	/
전화 받기 / 통화 종료	두 번 탭합니다 (L/R).	두 번 탭합니다 .
통화 수신 거부	2 초간 길게 누릅니다 (L/R).	2 초간 길게 누르기
음성 지원 소프트웨어 활성화	두 번 탭합니다 (L).	/

# 전원 끄기

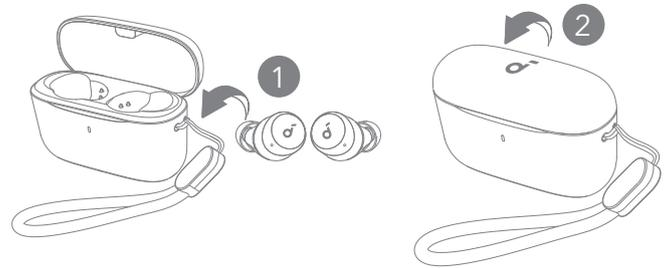

전원을 끄려면 이어버드를 충전 케이스 안에 다시 넣고 뚜껑을 닫습니다. 이어버드는 연결되지 않은 상태로 30 분이 지나면 자동으로 전원이 꺼집니다.

# 초기화

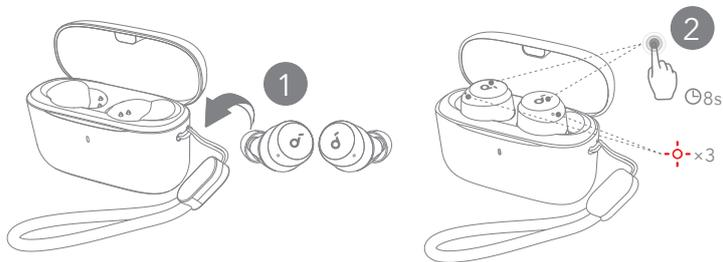

이어버드 간에 또는 다른 장치와 페어링하는 데 문제가 있는 경우 초기화하십시오. 이어버드를 충전 케이스에 넣고 케이스를 열어놓은 채로 양쪽 이어버드의 터치패드를 8 초간 누르고 떼어보세요. 그리고 이어버드의 LED 표시등이 빨리 3 번 깜박일 때까지 기다려주세요.

# LED 표시등 가이드

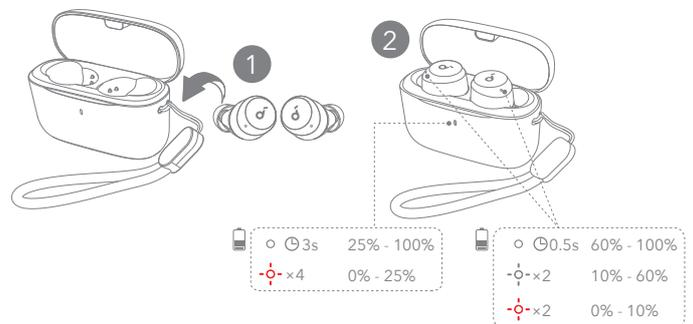

- 흰색으로 유지됨
- 흰색으로 깜박임
- 빨간색으로 점멸

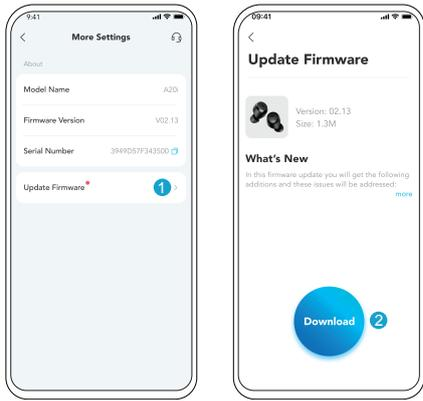

이어버드를 앱에 연결할 때 새로운 펌웨어 버전이 감지되면 알림이 전송됩니다. 펌웨어 업데이트가 완료될 때까지 이어버드가 충전 케이스 안에 놓여 있고 케이스가 열려 있는지 확인하십시오. 업데이트 중에는 이어버드가 충전 중인지 확인하고 사용을 피하십시오.

사양은 사전 통지 없이 변경될 수 있습니다.

입력	5V --- 0.5A
정격 출력 전원	5mW
배터리 용량	60mAh × 2( 이어버드 ), 350Ah ( 충전 케이스 )
충전 시간	최대 2 시간
재생 시간 ( 볼륨 수준과 사용 콘텐츠에 따라 달라짐 )	최대 9 시간 ( 충전 케이스 포함 시 최대 28 시간 )
드라이버 유닛	6mm 다이내믹 드라이버
주파수 응답	20Hz~20kHz
임피던스	16 - Ω
방수 수준 ( 이어버드 )	IPX5
Bluetooth 버전	5.3
Bluetooth 범위	10m



## 应用



Google Play and the Google Play logo are trademarks of Google Inc.



Apple and the Apple logo are trademarks of Apple Inc.



下载 soundcore 应用程序以体验全套功能，例如游戏模式、查找设备、EQ 调整、固件更新等。  
如果您的耳机无法连接 soundcore 应用程序，请在您的移动应用程序商店中将其更新到最新版本。



## 佩戴

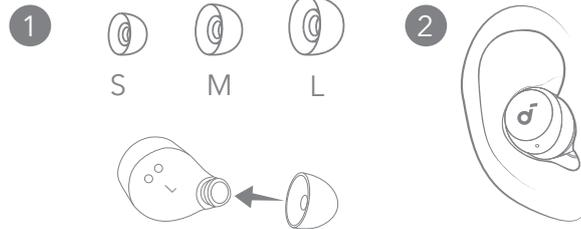

选择最适合自己耳朵的耳帽。



## 充电

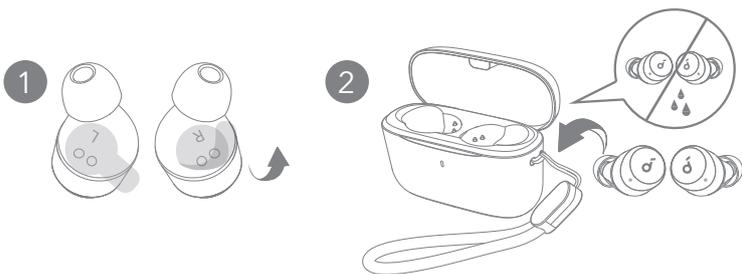

- 首次使用前请撕掉耳机上的绝缘贴纸。
- 将耳机放入充电盒，并关上充电盒。
  - 充电前请确保耳机和 USB-C 充电端口完全干燥。

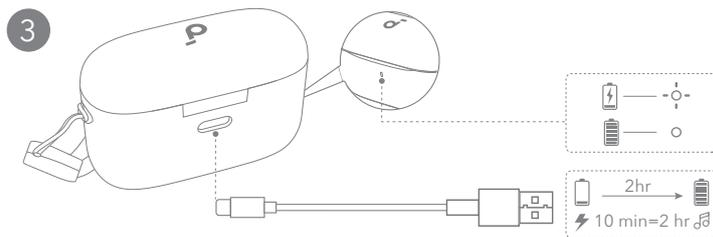

- 使用经过认证的 USB-C 充电线将充电盒连接到电源。
  - 首次使用前，请确保充电盒连同耳机充满电。



## 开机和配对

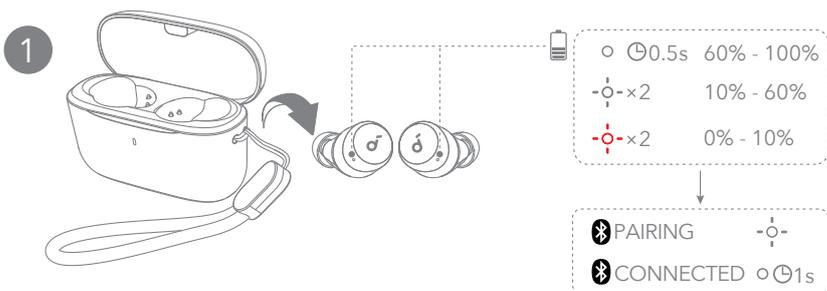

打开充电盒并将耳机从充电盒取出。它们将自动开机并进入蓝牙配对模式。

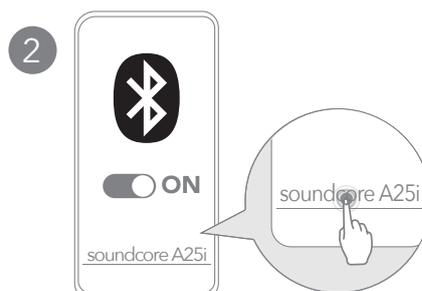

首次连接时，从设备的蓝牙列表中选择“soundcore A20i / A25i”\*。  
\* 设备名称可能因地区而异。

## 手动配对

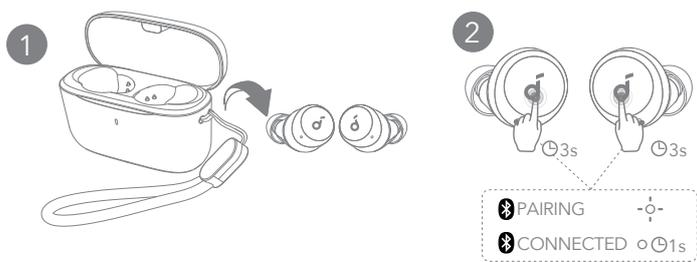

要手动进入蓝牙配对模式，请将耳机从充电盒中取出，然后在两个耳机的触摸板上轻按 3 秒钟，直到耳机的 LED 指示灯快速闪烁为止。

## 控制

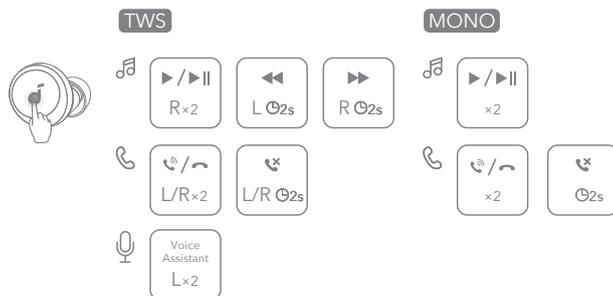

您还可以在 soundcore 应用中自定义控件。

## 控制

	TWS 模式	Mono 模式
播放 / 暂停	点击两次 (右)	点击两次
上一曲目	点击并按住 2 秒钟 (L)	/
下一曲目	点击并按住 2 秒钟 (R)	/
接听 / 结束通话	点击两次 (左 / 右)	点击两次
拒绝来电	按住 2 秒 (左 / 右)	点击并按住 2 秒钟
激活语音助手	点击两次 (左)	/

## 关机

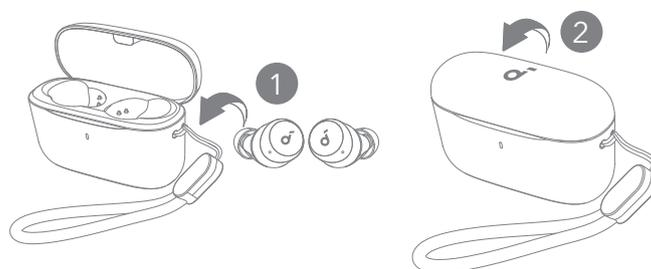

如需关机，将耳机放回充电盒并关闭充电盒。如果超过 30 分钟没有连接，耳机将自动关机。

## 重置

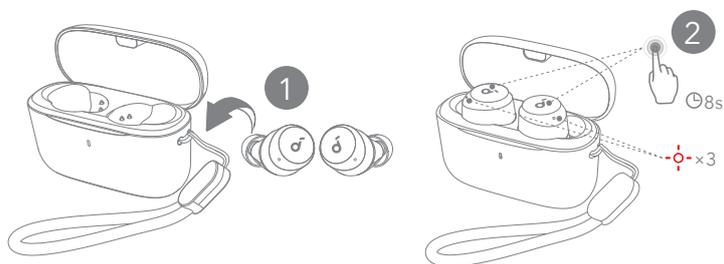

如果耳机在与其他设备配对时遇到问题，请重置耳机。将耳机放入充电盒并保持开盒状态，然后在两个耳机的触摸板上轻轻点击并长按 8 秒钟，直到耳机的 LED 指示灯快速闪烁三次变成红色。

## LED 指示灯指南

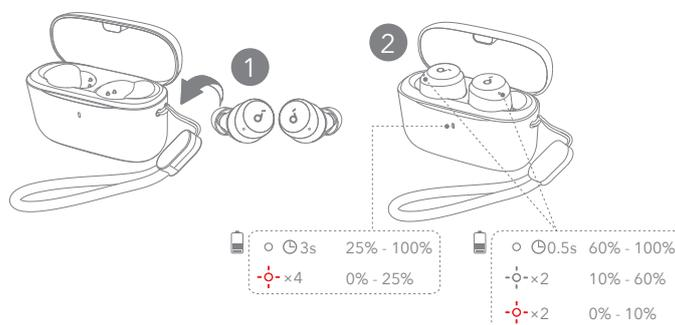

- 白色常亮
- 白灯闪烁
- 红色闪烁



## 固件更新

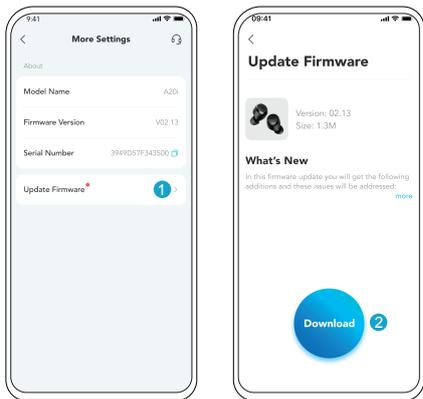

当您使用该应用程序连接耳机时，将会在检测到有新版本的固件时通知您升级。升级过程中，请确保将耳机放入充电盒并保持开盒状态，直至固件更新完成。更新过程中，请确保耳机在充电状态且勿进行任何使用。



## 规格

规格如有变更，恕不另行通知。

输入	5V --- 0.5A
额定输出功率	5mW
电池容量	60mAh × 2 (耳机) ; 350Ah (充电盒)
充电时长	最长可达 2 小时
播放时间 (因音量和内容而异)	最长可达 9 小时 (连带充电盒可达 28 小时)
驱动单元	6 毫米动圈驱动器
频率范围	20Hz - 20kHz
阻抗	16 Ω
防水等级 (耳机)	IPX5
蓝牙版本	5.3
蓝牙范围	10 米 /33 英尺



## 應用程式



Google Play and the Google Play logo are trademarks of Google Inc.



Apple and the Apple logo are trademarks of Apple Inc.



請下載 soundcore 應用程式來體驗全方位功能，例如遊戲模式、尋找裝置、EQ 微調、韌體更新等。

如果您的耳機無法連接 soundcore 應用程式，請在您的行動應用程式商店中更新到最新版本。



## 穿戴

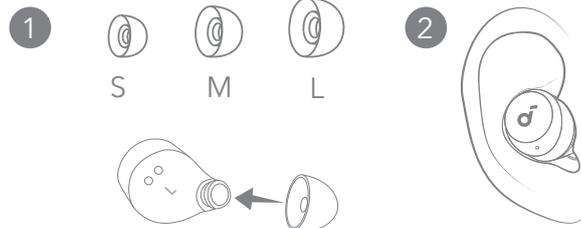

選擇最適合您耳朵的耳塞。



## 充電

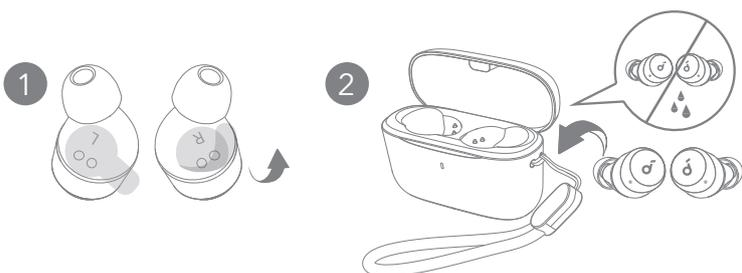

1. 初次使用前，先將耳塞式耳塞的絕緣貼紙撕下。
2. 將耳機裝入充電盒，並關上充電盒。

• 充電之前，先將耳機和 USB-C 充電埠完全擦乾。

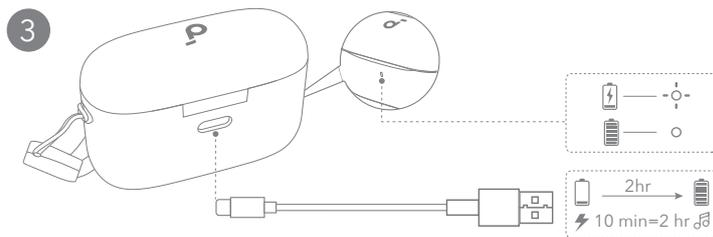

3. 使用經認證的 USB-C 充電線將充電盒連接至電源。

• 初次使用之前，請先對耳機和充電盒充飽電力。



## 開機和配對

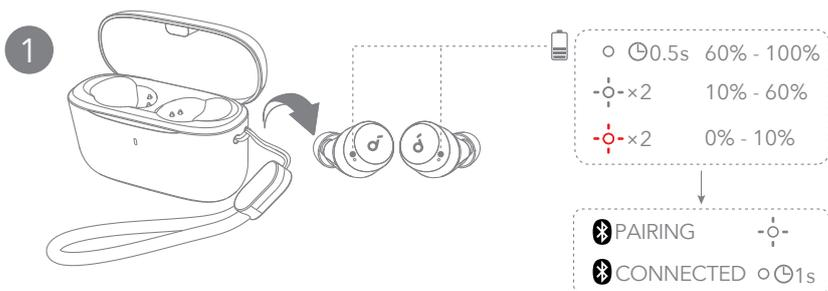

打開充電盒，再將耳機取出。其將自動開啟電源，並進入藍牙配對模式。

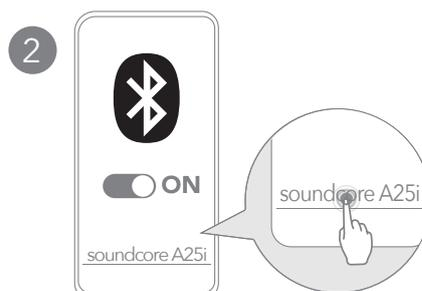

首次連接時，請從裝置的藍牙清單中選擇 **soundcore A20i / A25i\***。  
\* 裝置名稱可能因地區而異。





## 韌體更新

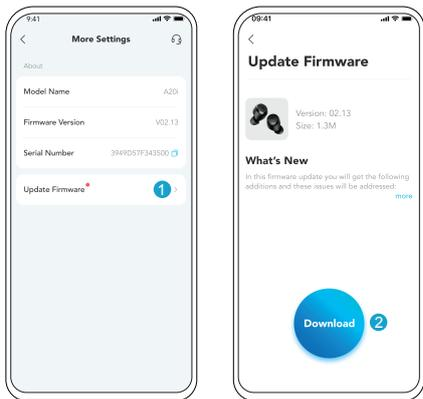

使用此應用程式與耳機連線時，只要偵測到新的韌體版本，就會通知您。此時務必將耳機放入充電盒中，但在韌體更新完成前，請勿關閉充電盒。更新期間，請確保耳機處於充電狀態，請勿使用耳機。



## 規格

規格可能隨時變更，恕不另行通知。

輸入	5V --- 0.5A
額定輸出功率	5mW
電池容量	60mAh × 2 ( 耳機 ) ; 350Ah ( 充電盒 )
充電時間	最多 2 小時
播放時間 ( 視音量大小與播放內容而有所不同 )	最多 9 小時 ( 使用充電盒時最多 28 小時 ) 。
單體	6 毫米動態驅動器
頻率響應	20Hz - 20kHz
阻抗	16 Ω
防水等級 ( 耳機 )	IPX5
藍牙版本	5.3
藍牙範圍	10m / 33ft



Google Play and the Google Play logo are trademarks of Google Inc.



Apple and the Apple logo are trademarks of Apple Inc.

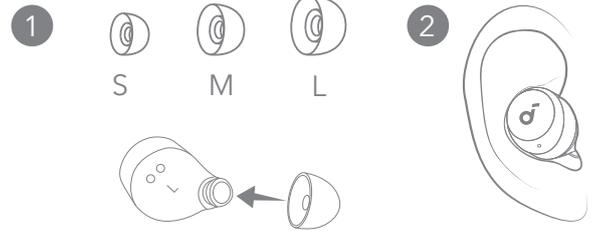

اختر القطع المطاطية المناسبة لأذنيك.

نزل تطبيق soundcore لتعزيز تجربتك (وضع الألعاب، العثور على الجهاز، ضبط الاتزان، تحديث البرامج الثابتة، والمزيد).  
إذا تعذر ربط سماعات الإيربوز الخاصة بك بتطبيق soundcore، فحدثه إلى أحدث إصدار موجود في متجر تطبيقات الأجهزة المحمولة.

## الشحن

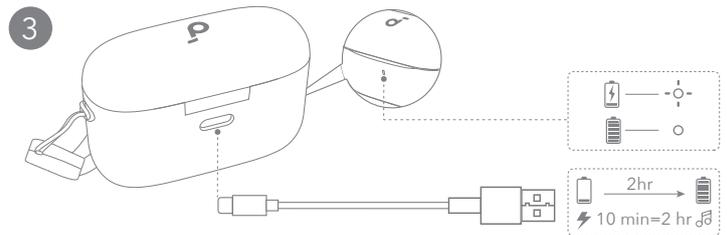
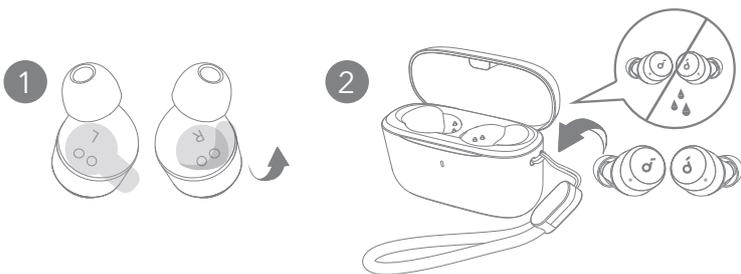

1. انزع ملصق العزل الموجود على سماعات الإيربوز قبل الاستخدام لأول مرة.
2. ضع سماعات إيربوز في علبة الشحن وأغلقها.
- جفف سماعات الإيربوز ومنفذ الشحن USB-C تمامًا قبل الشحن.

3. يرجى توصيل علبة الشحن بمصدر طاقة باستخدام كابل شحن USB-C معتمد.
- اشحن كلاً من سماعات الأذن وحافظة الشحن بالكامل قبل الاستخدام الأول.

## التشغيل والاقتران

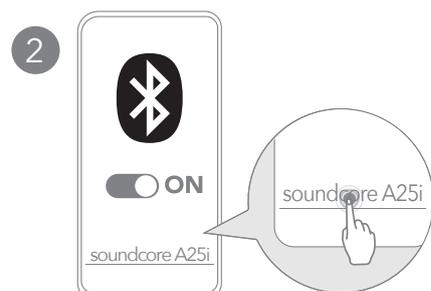
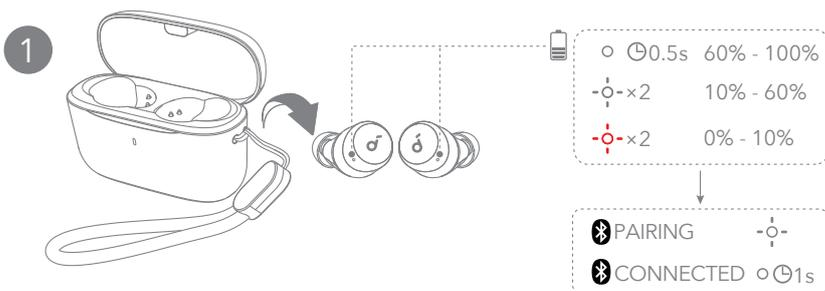

افتح حافظة الشحن وخذ سماعات الأذن. سيتم تشغيلها تلقائيًا والدخول في وضع الاقتران عبر Bluetooth.

حدد "soundcore A20i / A25i" \* في قائمة بلوتوث جهازك عند الاتصال للمرة الأولى.  
\* قد يختلف اسم الجهاز حسب المنطقة.

## الاقتران اليدوي

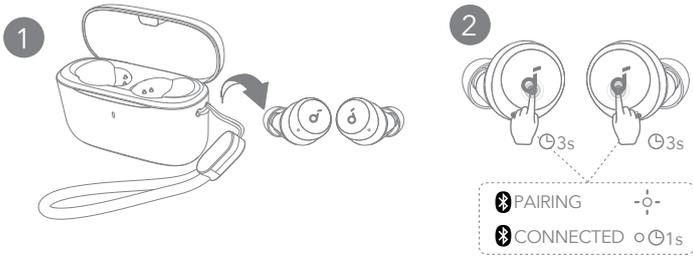

للدخول يدويًا إلى وضع الإقتران بالبلوتوث، خذ سماعات الأذن من العلبة، ثم اضغط واستمر في الضغط على زر اللمس في كلتي السماعات لمدة 3 ثوانٍ حتى تومض مؤشرات LED الخاصة بالسماعات باللون الأبيض بشكل سريع.

## عناصر التحكم

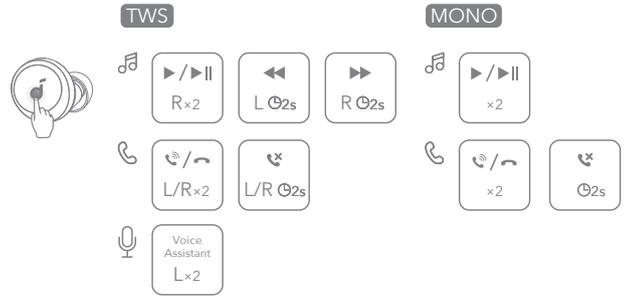

يمكنك تخصيص عناصر التحكم في تطبيق soundcore.

## عناصر التحكم



الوضع الأحادي	وضع (TWS) الأجهزة الإضافية	
اضغط مرتين	اضغط مرتين (يمينًا)	تشغيل / إيقاف
	اضغط مع الاستمرار لمدة ثانيتين (اليسرى)	المسار السابق
	اضغط مع الاستمرار لمدة ثانيتين (اليمنى)	المقطع الصوتي التالي
اضغط مرتين	اضغط مرتين (يمينًا/يسارًا)	الرد على مكالمة / إنهاؤها
اضغط مع الاستمرار لمدة ثانيتين	اضغط مطولاً لمدة 2 ثواني (يمينًا/يسارًا)	رفض مكالمة
/	اضغط مرتين (يسارًا)	تنشيط برنامج المساعدة الصوتية

## إيقاف التشغيل

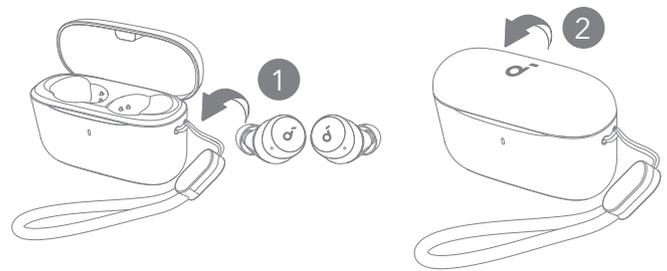

لإيقاف التشغيل، أعد سماعتى الإيربذ إلى علبة الشحن وأغلقها. سوف يتم إيقاف تشغيل سماعات الأذن تلقائيًا بعد 30 دقيقة إذا لم يتم توصيلها.

## إعادة الضبط

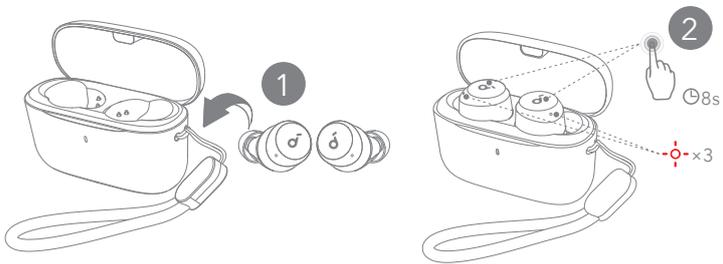

أعد ضبط سماعات الإيربذ إذا كانت تواجه مشكلات في الإقتران مع بعضها البعض أو مع الأجهزة الأخرى. ضع سماعات الأذن في حاوية الشحن واترك الحاوية مفتوحة، ثم اضغط واستمر في الضغط على زر اللمس في كلتي سماعات الأذن لمدة 8 ثوانٍ حتى تومض مؤشرات LED الخاصة بسماعات الأذن باللون الأحمر بسرعة ثلاث مرات.

## دليل مصباح LED

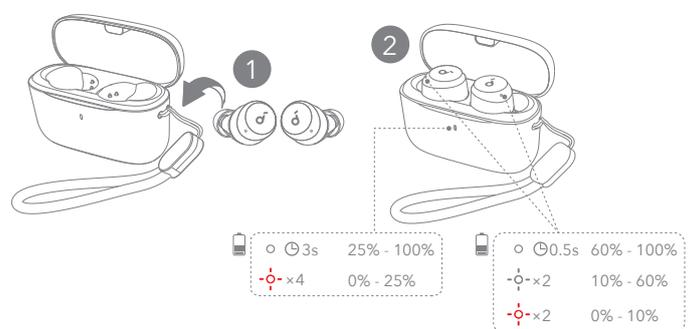

- أبيض ثابت ○
- أبيض وامض ○
- أحمر وامض ○



المواصفات عرضة للتغيير دون إشعار.

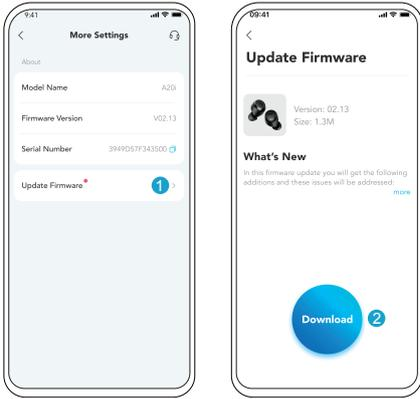

سيتم إعلامك بمجرد اكتشاف إصدار جديد من البرامج الثابتة عندما تقوم بتوصيل سماعات الأذن بالتطبيق. تأكد من وضع سماعات الأذن في حاوية الشحن وأن الحاوية مفتوحة حتى يتم الانتهاء من تحديث البرامج الثابتة. أثناء التحديث، تأكد من شحن سماعات الأذن وتجنب أي استخدام.

الدخل	5 فولت --- 0.5 أمبير
طاقة الإخراج المُصنفة	5 مللي واط
سعة البطارية	60 مللي أمبير/ساعة × 2 (سماعتي الإيربذ)؛ 350 أمبير في الساعة (حاوية الشحن)
مدة الشحن	ما يصل إلى ساعتين
وقت التشغيل (يختلف بحسب مستوى الصوت والمحتوى)	حتى 9 ساعات (حتى 28 ساعة مع حاوية الشحن)
وحدة مشغل	مشغل ديناميكي بحجم 6 ملم.
استجابة التردد	20 هرتز إلى 20 كيلو هرتز
المقاومة	16Ω
مستوى مقاومة الماء (سماعتنا الإيربذ)	IPX5
إصدار Bluetooth	5.3
نطاق Bluetooth	10 م / 33 قدمًا



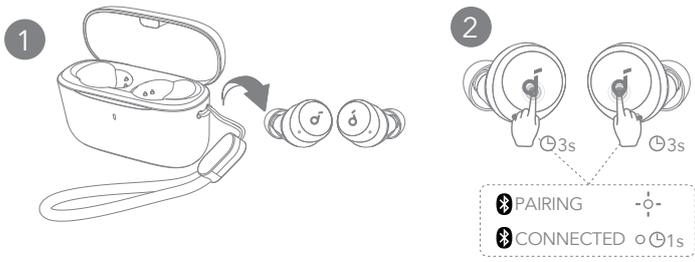

כדי להיכנס למצב התאמה של Bluetooth באופן ידני, הוצא את האוזניות מהמגינים, ולאחר מכן הקש והחזק את המשטחים המגעים בשתי האוזניות למשך 3 שניות עד שאינדיקטורי ה-LED של האוזניות יהפכו להבהב לבן בצורה מהירה.

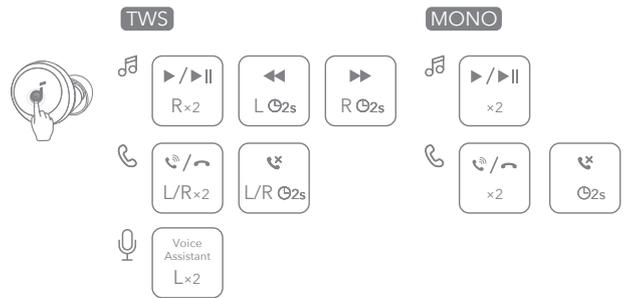

ניתן גם להתאים אישית את הפקדים באמצעות אפליקציית soundcore.



מצב מונו	TWS מצב	
לחיצה כפולה	הקשה פעמיים (ימין)	הפעלה/השהיה
/	הקש והחזק במשך 2 שניות (L)	הרצועה הקודמת
/	הקש והחזק במשך 2 שניות (R)	הרצועה הבאה
לחיצה כפולה	הקשה פעמיים (שמאל/ימין)	מענה לשיחה/סיום שיחה
הקש והחזק במשך 2 שניות	הקש והחזק למשך 2 שניות (שמאל/ימין)	דחיית שיחה
/	הקש פעמיים (שמאל)	הפעלת תוכנת עוזר קולי

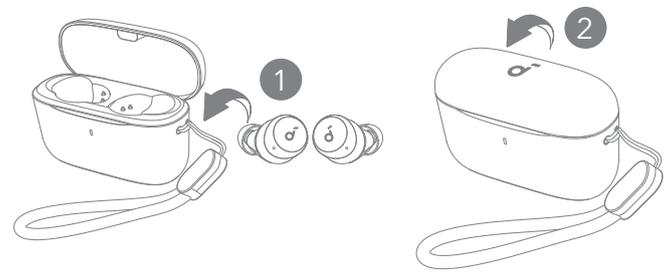

לכיבוי, החזר את האוזניות למארז הטעינה ולסגור את המארז. האוזניות יכבו אוטומטית לאחר 30 דקות אם הן לא מחוברות.

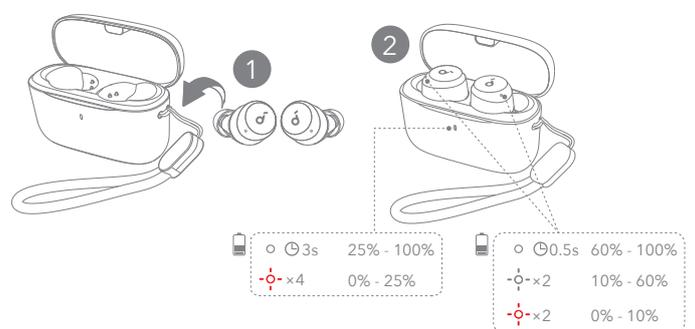
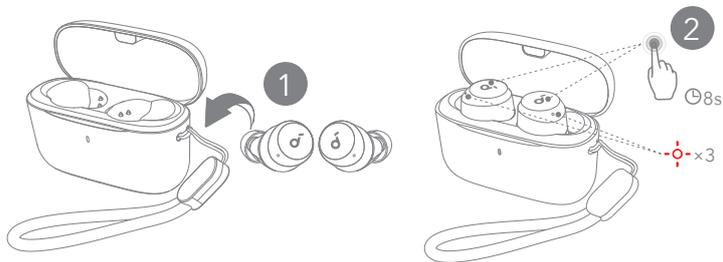

אם יש בעיות בצימוד של האוזניות כהלכה אחת לשנייה או למכשירים אחרים, יבצע איפוס. שים את אוזניות האזניות בתיבת הטעינה והשאר את התיבה פתוחה, לאחר מכן הקש והחזק את משטחי המגע על שתי אוזניות האזניות למשך 8 שניות עד שאינדיקטורי ה-LED של האוזניות יהפכו אדומים במהירות שלוש פעמים.

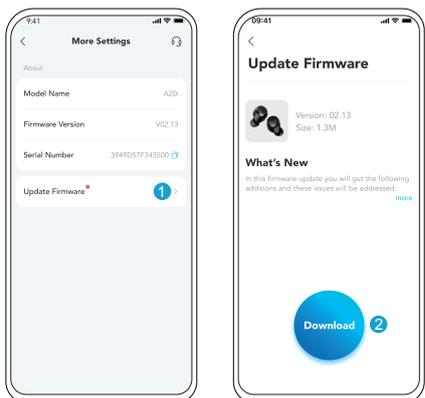

אתה אמור לקבל הודעה כאשר גרסת תוכנה חדשה יזוהה כאשר תחבר את האוזניות ליישום. ודא שהאוזניות מונחות בתיבת הטעינה והתיבה נשאר פתוחה עד להשלמת עדכון הקושחה. במהלך העדכון, ודא שהאוזניות מטענות והימנע מכל שימוש.

המפרט כפוף לשינויים ללא הודעה מראש.

קלט	5V --- 0.5A
הספק מתח נקוב	5mW
קיבולת סוללה	2 × 60mAh (אוזניות כפתור); 350 אמפר (מארז טעינה)
זמן טעינה	עד 2 שעות
זמן השמעה (משתנה לפי עוצמת הקול והתוכן)	עד 9 שעות (עד 28 שעות עם תיק הטעינה)
יחידת מנהל ההתקן	מנוע דינמי בקוטר 6 מ"מ
היענות תדרים	20 הרץ - 20 קילו הרץ
עכבה	16Ω
רמת עמידות במים (אוזניות כפתור)	IPX5
גרסת Bluetooth	5.3
סווח Bluetooth	10 מ' / 33 רגל