

For FAQs and more information, please visit:
anker.com/support



Charge Fast, Live More



@anker_official
@anker_jp



@Anker Deutschland
@Anker Japan
@Anker



@AnkerOfficial
@Anker_JP



Anker **535** Portable Power Station
(PowerHouse 512Wh)

USER MANUAL

Product Number: A1751 51005003152 V03



English 01

日本語 09

Overview

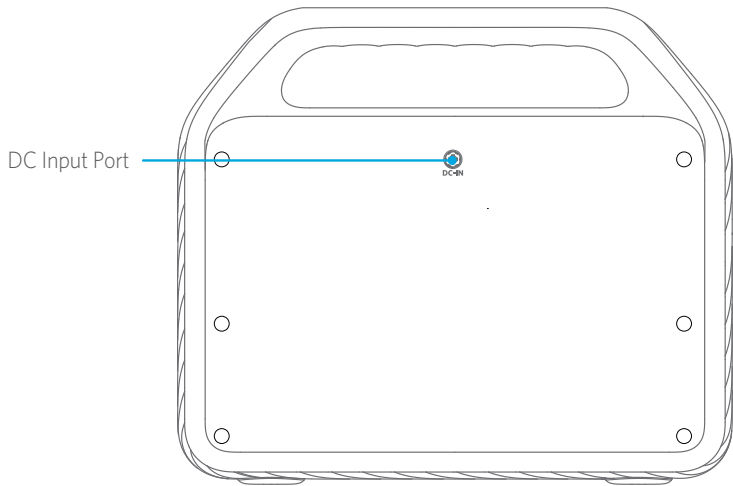
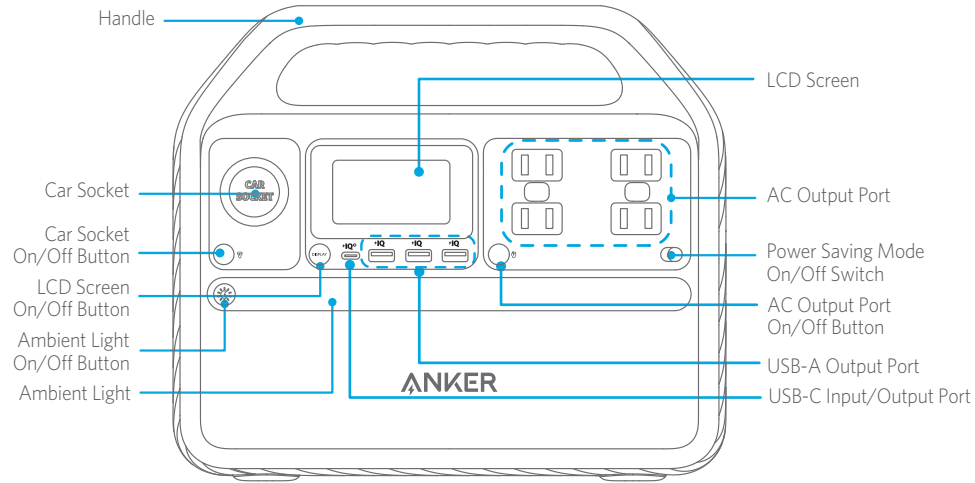

Recharging Your Power Station

① 60 W

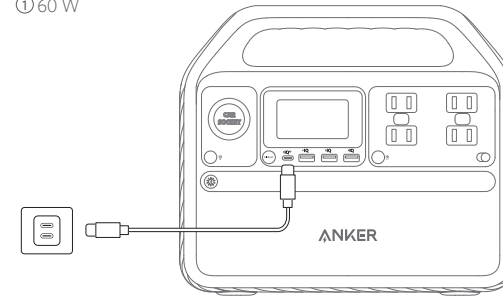

② 120 W

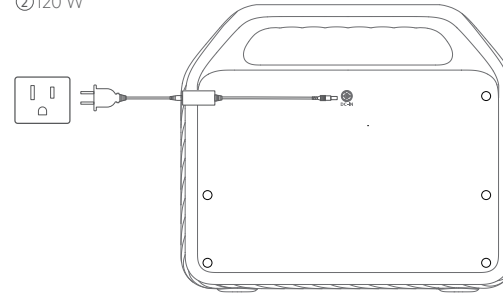

③ 180 W

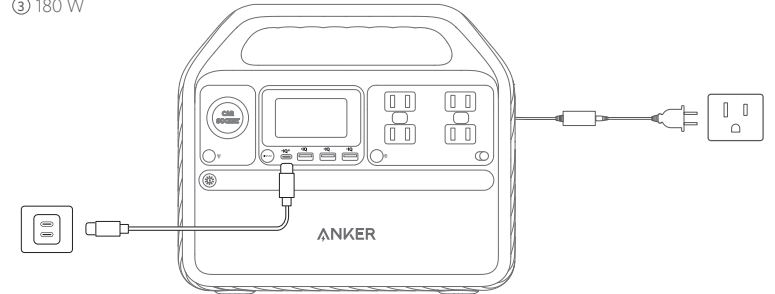

④ 120 W

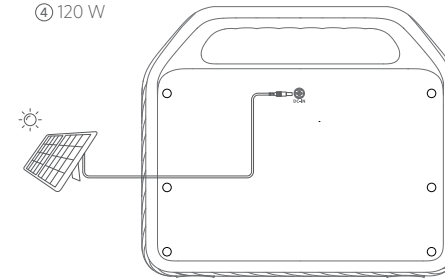

⑤ 120 W

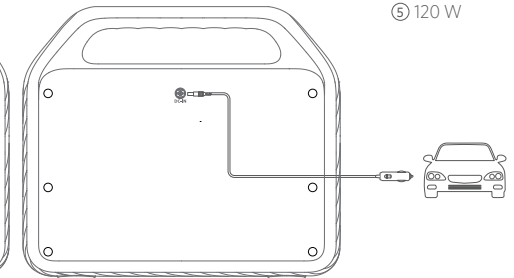

- Please fully charge the product before using it for the first time.
- When your portable power station only has 1% battery remaining, the indicators will flicker to remind you to recharge the device.

Powering Your Devices

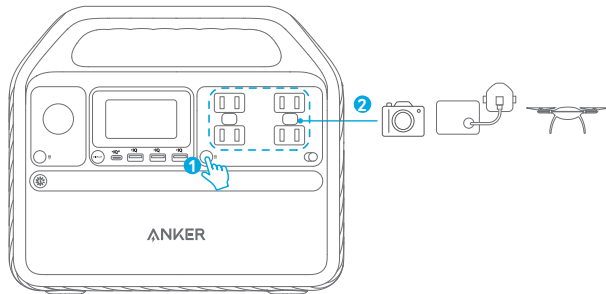
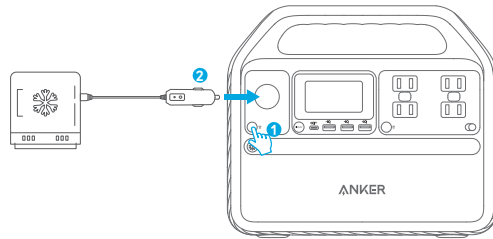
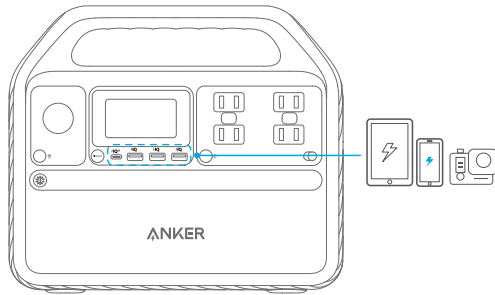

1. The USB-A and USB-C ports support plug and charge. When devices are plugged in, they will start charging automatically; when devices are unplugged, they will turn off automatically.
2. The car socket and AC output port do not support plug and charge. Use the corresponding on/off buttons to turn them on before charging.
3. To avoid draining the battery, we recommend keeping Power Saving Mode turned on except when you are charging low-powered devices like CPAP machines and cameras.

Power Saving Mode

Switching on the power saving mode prevents wasting power by automatically turning off the Power Station once all your devices are fully charged.

Switching off the power saving mode will enable stable charging over an extended period, such as for time-lapse photography or for sleeping with a CPAP machine.

LCD Screen Guide

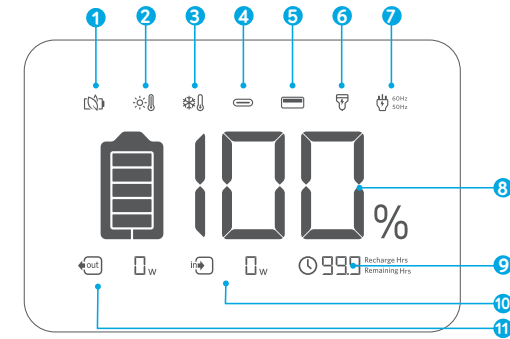

- 1 Power Saving Mode
- 2 High-Temperature Alert
 - When this icon shows, stop using the product and leave it to cool down until the icon disappears.
- 3 Low-Temperature Alert
 - When this icon shows, stop using the product until the icon disappears.
- 4 USB-C Input/Output Port
- 5 USB-A Output
- 6 Car Charging
- 7 60Hz
50Hz
AC Charging and Voltage Frequency
Press the AC output port on/off button for 2 seconds to switch the frequency.
- 8 100%
Remaining Battery
- 9 999 Recharge Hrs
Remaining Hrs
Remaining Battery in Hours
- 10 in W
Current Input Power
- 11 out W
Current Output Power

Flashlight Mode

Press the button once to turn on the ambient light.

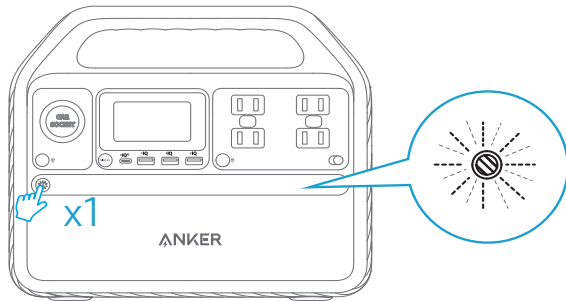

Hold the button for 2 seconds to turn on SOS mode.

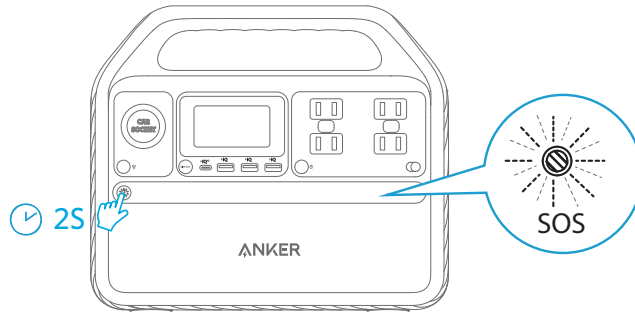

Trouble Shooting

Resetting Your Power Station

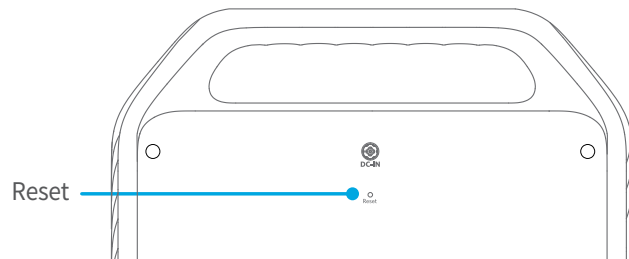

If your Power Station isn't working correctly, insert a paper clip or pin into the reset hole for 1 second for a factory reset. If the Power Station still doesn't work, please contact support@anker.com.

FAQ

Q1: What's the max power output of the AC port?

500W, and if you use the AC port for devices greater than 500W, the product will automatically turn off.

Q2: Can I recharge the product while charging connected devices?

Yes.

Q3: Can this product power a CPAP?

Yes, but do not forget to turn off the Power Saving Mode first.

Q4: Will this product lose power automatically if not powered off?

Yes, when the car socket or AC control button is turned on, even if no devices are being charged, there will still be a certain amount of no-load power consumption. To avoid draining the battery, we recommend keeping Power Saving Mode turned on except when you are charging low-powered devices like CPAP machines and cameras.

Q5: What kind of solar charger can charge this product?

Any 11V-28V solar charger with a DC 8mm (DC 7909) male connector.

Specifications

Cell Capacity	512 Wh
DC Input	11-28V \equiv 10A (120W Max)
Car Charger Output	12V \equiv 10A
AC Output	110V- 4.54A, 50Hz/60Hz, 500W
USB-A Output	5V \equiv 7.2A (2.4A Max Per Port)
USB-C Input	5V \equiv 3A/ 9V \equiv 3A/ 15V \equiv 3A/20V \equiv 3A (60W Max)
USB-C Output	5V \equiv 3A/ 9V \equiv 3A/ 15V \equiv 3A/20V \equiv 3A (60W Max)
Discharging Temperature	-4°F-104°F / -20°C-40°C
Charging Temperature	32°F-104°F / 0°C-40°C
Size	29.16*25.1*18.8cm/ 11.48*9.88*7.4 in
Net Weight	7.6 kg / 16.75 lbs
Gross Weight	8.87kg / 19.55 lbs

Attention



Not permitted on aircraft.

IMPORTANT SAFETY INSTRUCTIONS

WARNING - When using this product, basic precautions should always be followed, including the following: Read all the instructions before using the product.

- To reduce the risk of injury, close supervision is necessary when the product is used near children.
- Do not put fingers or hands into the product.
- Do not expose the product to rain or snow.
- Use of a power supply or charger not recommended or sold by the product manufacturer may result in a risk of fire or injury to persons.

To reduce risk of damage to the electric plug and cord, pull the plug rather than the cord when disconnecting the product.

- Do not use the product in excess of its output rating. Overload outputs above rating may result in a risk of fire or injury to persons.
- Do not use the product that is damaged or modified. Damaged or modified batteries may exhibit unpredictable behavior resulting in fire, explosion or risk of injury.

Do not operate the product with a damaged cord or plug, or a damaged output cable.

- Do not disassemble the product. Take it to a qualified service person when service or repair is required. Incorrect reassembly may result in a risk of fire or electric shock.
- Do not expose to fire or high temperatures. Exposure to fire or temperatures above 130°C may cause explosion. To reduce the risk of electric shock, unplug the power pack from the outlet before attempting any instructed servicing.
- Have servicing performed by a qualified repair person using only identical replacement parts. This will ensure that the safety of the product is maintained.
- When charging a device, the product may feel warm, this is a normal operating condition and should not be cause for concern.

When charging the internal battery, work in a well ventilated area and do not restrict ventilation in any way.

- Do not clean the product with harmful chemicals or detergents.
- Misuse, dropping or excessive force may cause product damage.
- When disposing of secondary cells or batteries, keep cells or batteries of different electrochemical systems separate from each other.
- Do not use or store the power station in direct sunlight for an extended period, such as in a car, cargo bed, or any other place where it will be exposed to high temperatures. Doing so may cause the product to malfunction, deteriorate, or generate heat.
- Do not use the product for applications such as data servers or medical equipment where a malfunction in an emergency could seriously endanger human life or property.

Storage and Maintenance instructions

1. Please store the product between 32°F-104°F (0°C-40°C). Avoid exposing the product to rain or using the product in a humid environment.
2. To preserve battery lifespan, please discharge the battery to 30% and recharge it to 60% every three months.
3. For safety, please do not store the product in an environment with a temperature higher than 113°F or lower than 14°F for an extended period of time.
4. Please keep the product laid flat during use, when charging, and during storage.

FCC Statement

This device complies with Part 15 of the FCC Rules. Operation is subject to the following two conditions: (1) This device may not cause harmful interference, and (2) this device must accept any interference received, including interference that may cause undesired operation.

Warning: Changes or modifications not expressly approved by the party responsible for compliance could void the user's authority to operate the equipment.

Note: This equipment has been tested and found to comply with the limits for a Class B digital device, pursuant to Part 15 of the FCC Rules. These limits are designed to provide reasonable protection against harmful interference in a residential installation.

This equipment generates, uses, and can radiate radio frequency energy and, if not installed and used in accordance with the instructions, may cause harmful interference to radio communications. However, there is no guarantee that interference will not occur in a particular installation. If this equipment does cause harmful interference to radio or television reception, which can be determined by turning the equipment off and on, the user is encouraged to try to correct the interference by one or more of the following measures:

- (1) Reorient or relocate the receiving antenna.
- (2) Increase the separation between the equipment and receiver.
- (3) Connect the equipment into an outlet on a circuit different from that to which the receiver is connected.
- (4) Consult the dealer or an experienced radio / TV technician for help.

The following importer is the responsible party.

Company Name: Fantasia Trading LLC

Address: 5350 Ontario Mills Pkwy, Suite 100, Ontario, CA 91764

Telephone: +1-800-988-7973

IC Statement

This device complies with Industry Canada license-ICES-003. Operation is subject to the following two conditions: (1) This device may not cause interference, and (2) This device must accept any interference, including interference that may cause undesired operation of the device.

Le présent appareil est conforme aux CNR d'Industrie Canada applicables aux appareils radio exempts de licence. L'exploitation est autorisée aux deux conditions suivantes : (1) l'appareil ne doit pas produire de brouillage, et (2) l'utilisateur de l'appareil doit accepter tout brouillage radioélectrique subi, même si le brouillage est susceptible d'en compromettre le fonctionnement.

This digital apparatus complies with CAN ICES-003(B)/NMB-003(B).

Declaration of Conformity

Hereby, Anker Innovations Limited declares that the product type A1751 is in compliance with Directives 2014/35/EU & 2014/30/EU & 2011/65/EU. The full text of the EU declaration of conformity is available at the following internet address:

<https://www.anker.com>

GB Declaration of Conformity

Hereby, Anker Innovations Limited declares that the product type A1751 is in compliance with Electrical Equipment (Safety) Regulations 2016 & Electromagnetic Compatibility Regulations 2016 & The Restriction of the Use of Certain Hazardous Substances in Electrical and Electronic Equipment Regulations 2012. The full text of the GB declaration of conformity is available at the following internet address:

<https://www.anker.com>.

Anker Innovations Limited | Room 1318-19, Hollywood Plaza, 610 Nathan Road, Mongkok, Kowloon, HongKong

The following importer is the responsible party (contract for EU and UK matters)

Anker Innovations Deutschland GmbH | Georg-Muche-Strasse 3, 80807 Munich, Germany

Anker Technology (UK) Limited,

GNR8, 49 Clarendon Road, Watford, Hertfordshire, WD17 1HP, United Kingdom

Customer Service



5-Year Limited Warranty

Please note that your rights under applicable law governing the sale of consumer goods remain unaffected by the warranties given in this Limited Warranty.



Lifetime Technical Support



support@anker.com

support.me@anker.com (For Middle East and Africa Only)



(US/CA) +1 (800)988 7973
(UK) +44 (0) 1604 936200
(DE) +49 (0) 69 9579 7960
(Middle East & Africa) +971 42428633
(UAE) +971 8000320817
(KSA) +966 8008500030
(Kuwait) +965 22069086
(Egypt) +20 8000000826
(AU) +61 3 8331 4800
(TR) +90 0850 460 14 14
(RU) +8 (800) 511-86-23
(India) +91 18003138831
(中国) +86 400 0550 036
(日本) 03 4455 7823
(韩国) +82 02-1670-7098

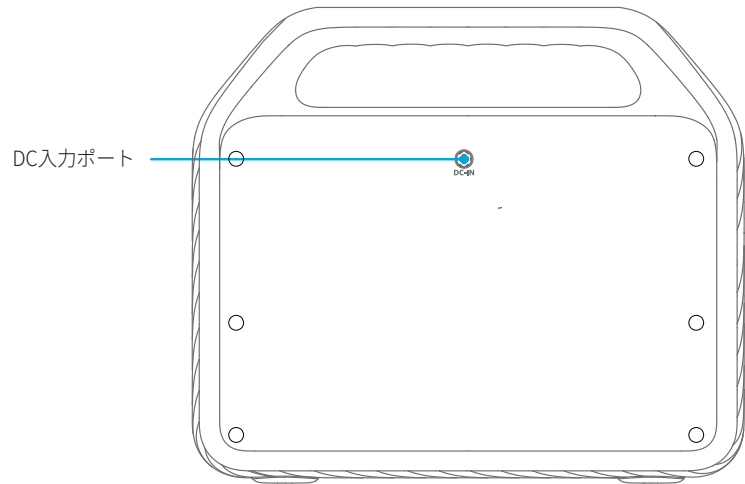
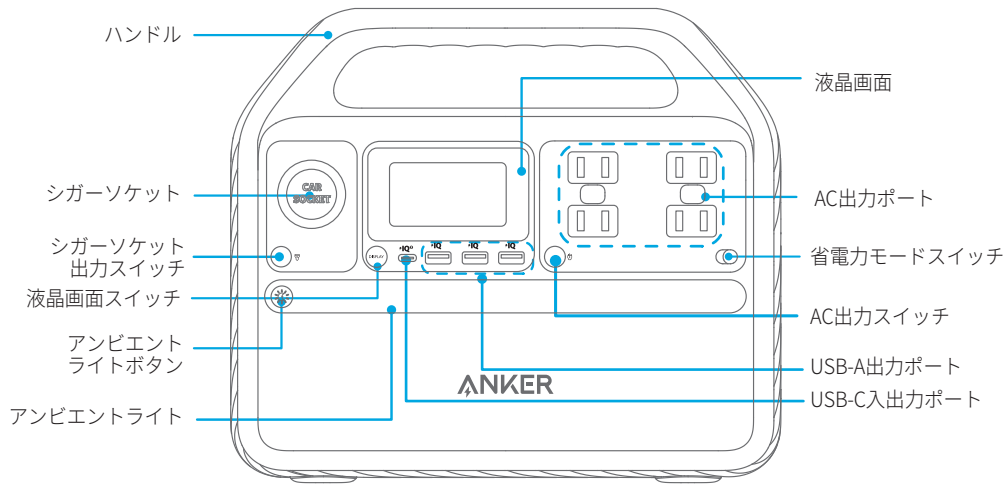

① 60 W

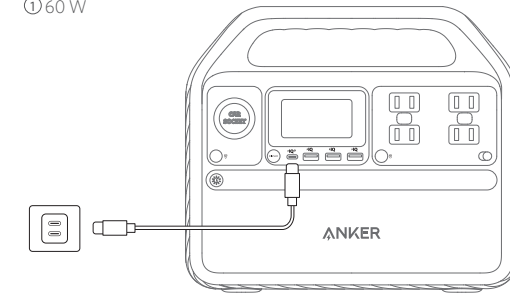

② 120 W

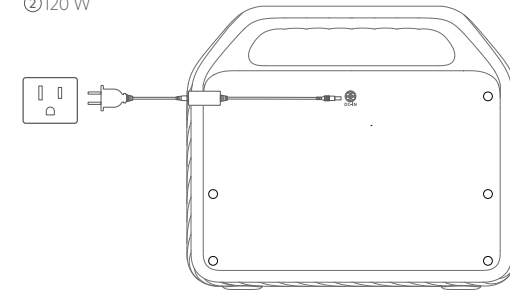

③ 180 W

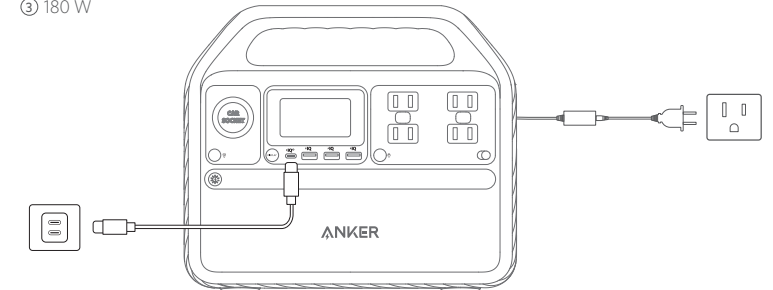

④ 120 W

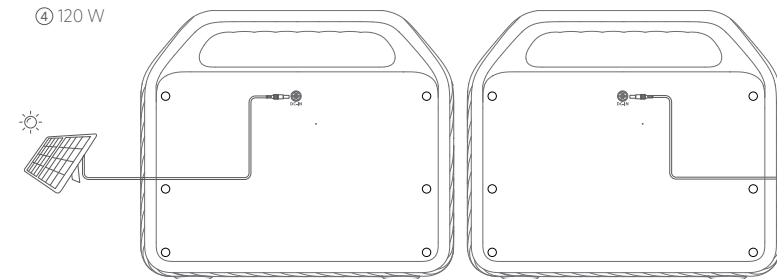

⑤ 120 W

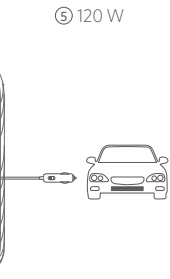

- 初めてご使用になる前に、本製品を満充電してください。
- 本製品のバッテリー残量が 1% 以下になると、バッテリー残量 (%) の表示が点滅し、本製品の充電が必要であることを通知します。

機器の充電

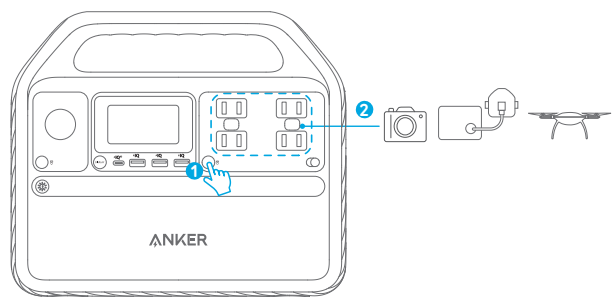
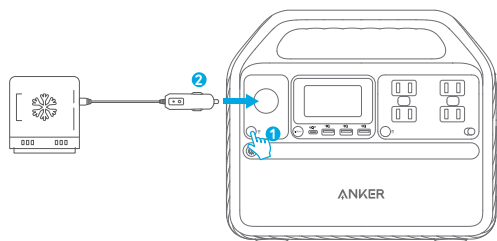
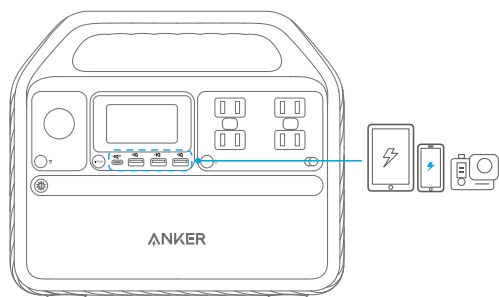

1. USB-A および USB-C ポートに機器を接続すると、自動的に充電を開始します。機器を取り外すと、自動的に充電を停止します。
2. シガーソケットと AC 出力ポートは、接続時に自動で充電が開始されません。充電する前に、対応する出力スイッチをオンにしてください。
3. バッテリー消費を抑えるため、カメラなどの低電力機器を充電する場合を除いて、省電力モードにしておくことをお勧めします。

省電力モード

省電力モードをオンにすると、機器を満充電した後に充電が自動で停止し、無負荷時消費電力によるバッテリー消費を防ぐことができます。また、出力ボタンをオフにし忘れた場合も同様に自動で出力を停止します。一方で、省電力モードをオフにすると、タイムラプス動画の撮影時など、低出力で長時間にわたり機器を使用する際に安定的に充電することができます。

液晶画面ガイド

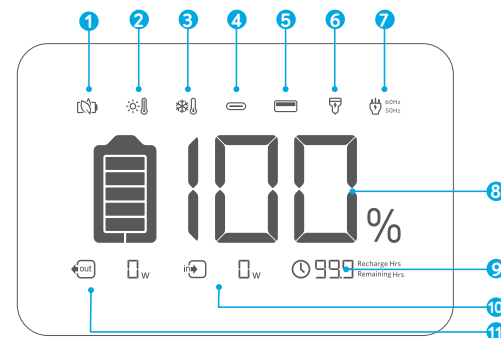

1 省電力モード



2 高温注意

• このアイコンが表示された場合、アイコンが消えるまで本製品の使用を停止してください。



3 低温注意

• このアイコンが表示された場合、アイコンが消えるまで本製品の使用を停止してください。



4 USB-C 入出力



5 USB-A 出力



6 シガーソケットからの充電



7 AC 出力と電源周波数

AC 出力スイッチを 2 秒間長押しして、周波数を切り替えます。



8 バッテリー残量 (%)



9 バッテリー残量 (時間)



10 入力電力



11 出力電力

フラッシュライトモード

1回押すと、アンビエントライトが点灯します。

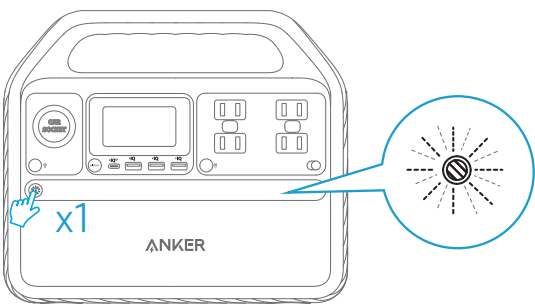

2秒間長押しすると、SOSモードに切り替わります。

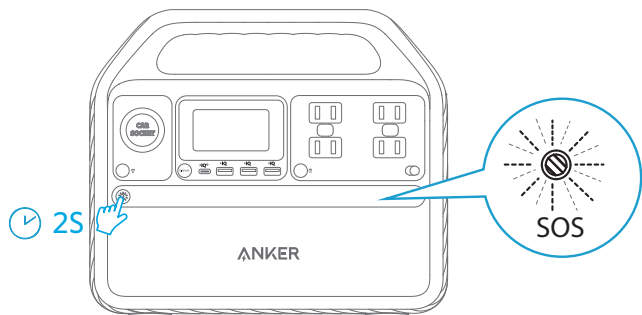

トラブルシューティング

リセット方法

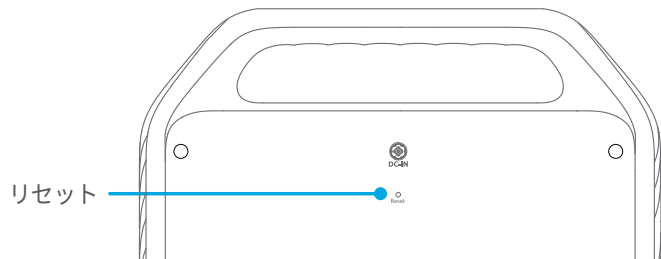

本製品が正常に機能しない場合は、クリップなど先端が細いものをリセットホールに1秒間差し込んでください。その後も正常に動作しない場合は、大変お手数ですがカスタマーサポート (support@anker.com) までお問い合わせください。

よくある質問

Q1: ACポートの最大出力はいくつですか？

500Wです。500Wを超える機器にACポートを使用すると、本製品は自動的にオフになります。

Q2: 接続機器を充電しながら同時に製品本体を充電できますか？

はい、できます。

Q3: 電源をオフにしないとバッテリーを消費しますか？

はい。シガーソケットまたはAC出力ポートのスイッチがオンになっていると、機器を充電していない状態でも一定の無負荷時消費電力が発生します。バッテリー消費を防ぐため、カメラなどの低電力機器を充電する場合を除いて、省電力モードをオンにしておくことをお勧めします。

Q4: どのようなソーラー充電器で本製品を充電できますか？

DC 8mm (DC 7909) オスコネクタを備えた11V~28V対応のソーラー充電器で充電できます。

製品の仕様

セル容量	512 Wh
DC 入力	11-28V ≒ 10A (最大 120W)
シガーソケット出力	12V ≒ 10A
AC 出力	110V~ 4.54A, 50Hz/60Hz, 500W
USB-A 出力	5V ≒ 7.2A (各ポート最大 2.4A)
USB-C 入力	5V ≒ 3A/ 9V ≒ 3A/ 15V ≒ 3A/ 20V ≒ 3A (最大 60W)
USB-C 出力	5V ≒ 3A/ 9V ≒ 3A/ 15V ≒ 3A/ 20V ≒ 3A (最大 60W)
動作温度 (機器の充電時)	-20° C~40° C
動作温度 (本製品の充電時)	0° C ~ 40° C
サイズ	約 29.2 × 25.1 × 18.8 cm
重さ (本体のみ)	約 7.6 kg
重さ (パッケージ含む)	約 8.87 kg

注意



航空機に持ち込むことはできません。

安全にご使用いただくために

警告 - 本製品を使用する際には、下記の注意事項をお守りください。

本製品を使用する前に、すべての指示をお読みください。

- 事故を防ぐため、お子様の手の届かないところでご使用ください。
- 製品のポートに指や手など身体の一部および異物を入れないでください。
- 本製品を雨や雪にさらさないでください。
- 製造元により販売または推奨されていない電源や充電器などを使用した場合、火事や怪我につながる恐れがあります。
- 電源プラグやコードの損傷を防ぐため、電源プラグをコンセントから抜くときは、コードではなくプラグを持って抜いてください。
- 本製品の定格出力を超える定格消費電力の製品に利用しないでください。火事や怪我につながる恐れがあります。
- 破損または改造した製品は使用しないでください。予期しない動作により、火事や爆発、怪我につながる恐れがあります。
- コードやプラグ、ケーブルが破損した状態で本製品を利用しないでください。
- 本製品を分解しないでください。修理が必要な場合は、カスタマーサポートまでご連絡ください。分解中または分解後に誤って組み立てる際に火事や怪我につながる恐れがあります。
- 火気や高温にさらさないでください。本製品は、130°C を超える高温にさらされると爆発を引き起こす恐れがあります。
- 本製品が破損している場合、使用を中止しカスタマーサポートにお問い合わせください。本製品の分解・改造などはしないでください。
- お使いの機器を充電する際、本体が温くなる場合がありますが、異常ではありません。本製品を充電する際は、風通しの良い場所で行ってください。
- お手入れの際に、危険性のある化学製品や洗剤などを使用しないでください。
- 誤使用、落下また過度な衝撃は製品の故障につながる恐れがあります。
- 炎天下の車内、トランク、荷台や直射日光下など高温になる場所で使用、保管しないでください。本製品の故障・劣化の原因、および発熱の原因となります。
- 同梱の電源コードは本製品のみにご使用ください。
- データサーバや医療機器など、非常時に不具合が起こると人命 / 財産に重大な危険を及ぼしうる用途でのご使用はお控えください。

保管およびお手入れ方法

1. 本製品は 0°C ~ 40°C の環境で保管してください。本製品を雨にさらしたり、湿気の多い環境で使用したりしないでください。
2. バッテリーを長持ちさせるために、3 か月ごとにバッテリーを 30% まで放電した後に 60% まで再充電してください。
3. 安全のため、温度が 45°C を超える、もしくは -10°C を下回る環境で本製品を長期間保管しないでください。
4. 機器への充電中や本体充電中、保管中は本製品を平らな場所に置いてください。

カスタマーサポート



最大 5 年保証（通常 18 ヶ月、Anker Japan 公式サイト会員登録で 5 年に延長）



テクニカルサポート



support@anker.com

support.mea@anker.com (For Middle East and Africa Only)



(US/CA) +1 (800)988 7973

(UK) +44 (0) 1604 936200

(DE) +49 (0) 69 9579 7960

(Middle East & Africa) +971 42428633

(UAE) +971 8000320817

(KSA) +966 8008500030

(Kuwait) +965 22069086

(Egypt) +20 8000000826

(AU) +61 3 8331 4800

(TR) +90 0850 460 14 14

(RU) +8 (800) 511-86-23

(India) +91 18003138831

(中国) +86 400 0550 036

(日本) 03 4455 7823

(韓国) +82 02-1670-7098